



# WORK XL1

Manual

ENGLISH

The Bluetooth® word mark and logos are registered trademarks owned by Bluetooth SIG, Inc. and any use of such marks by Caliber Europe B.V. is under license.

## IMPORTANT SAFETY INSTRUCTIONS

GB

1. Read these instructions.
2. Keep these instructions.
3. Heed all warnings.
4. Follow all instructions.
5. Do not use this apparatus near water.
6. Clean only with dry cloth.
7. Do not block any ventilation openings. Install in accordance with the manufacturer's instructions.
8. Do not install near any heat sources such as radiators, heat registers, stoves, or other apparatus (including amplifiers) that produce heat.
9. Do not defeat the safety purpose of the polarized or grounding-type plug. A polarized plug has two blades with one wider than the other. A grounding type plug has two blades and a third grounding prong. The wide blade or the third prong are provided for your safety. If the provided plug does not fit into your outlet, consult an electrician for replacement of the obsolete outlet.
10. Protect the power cord from being walked on or pinched particularly at plugs, convenience receptacles, and the point where they exit from the apparatus.

11. Only use attachments/accessories specified by the manufacturer.
12. Use only with the cart, stand, tripod, bracket, or table specified by the manufacturer, or sold with the apparatus. When a cart is used, use caution when moving the cart/apparatus combination to avoid injury from tip-over.



13. Unplug this apparatus during lightning storms or when unused for long periods of time.
14. Refer all servicing to qualified service personnel. Servicing is required when the apparatus has been damaged in any way, such as power-supply cord or plug is damaged, liquid has been spilled or objects have fallen into the apparatus, the apparatus has been exposed to rain or moisture, does not operate normally, or has been dropped.
15. To Reduce the Risk of Fire or Electric Shock, Do not Expose This Appliance To Rain or Moisture.
16. The Shock Hazard Marking and Associated Graphical Symbol is provided on the rear of unit.
17. Apparatus shall not be exposed to dripping or splashing and no objects filled with liquids, shall be placed on the apparatus.

18. Excessive sound pressure on ear- and headphones could impair the hearing ability. Higher setting that idle on the equalizer leads to higher signal voltages on the output for ear and headphones.
19. The power plug should be close to the radio, and easy to be approached that during the emergency, to disconnect the power from the radio, just unplug the power plug from the AC power slot.
20. Where the MAINS plug or an appliance coupler is used as the disconnect device, the disconnected device shall remain readily operable.
21. The batteries shall not be exposed to excessive heat such as sunshine, fire or the like.
22. This apparatus is provided with protection against dust ingress and splashing water (IP64).

**CAUTION:** These servicing instructions are for use by qualified service personnel only. To reduce the risk of the electric shock, do not perform any servicing other than that contained in the operating instructions unless you are qualified to so.

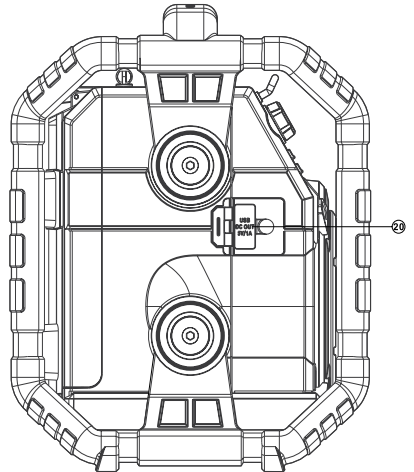
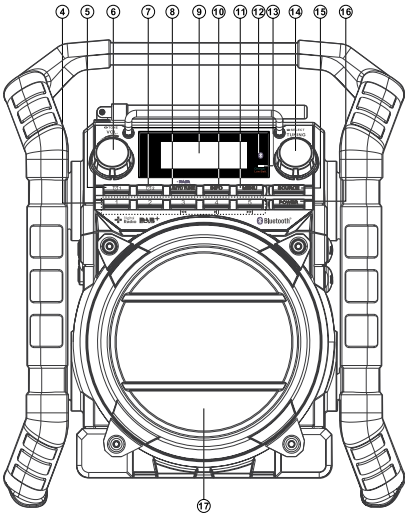
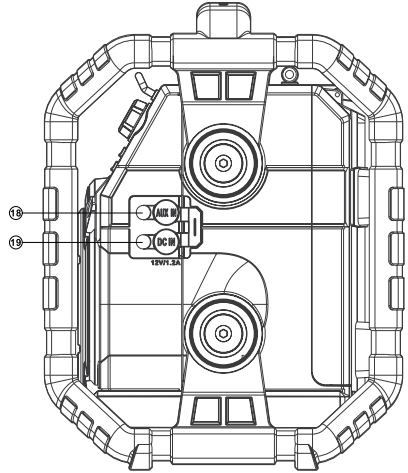
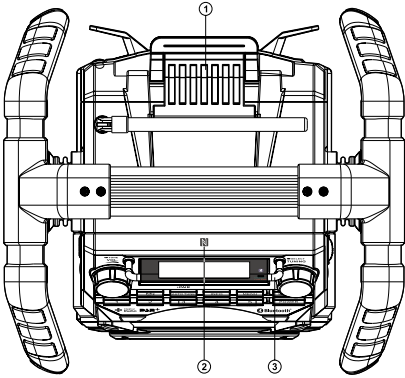

# Control

- ① Battery locker
- ② NFC detection tag
- ③ Display protection bar
- ④ Preset button (Preset 3: rewind button/Preset 4: Play/Pause/Preset 5: Fast-forward button)
- ⑤ Alarm 1 button
- ⑥ Volume control/Tone control
- ⑦ Alarm 2 button
- ⑧ Auto tune button/Bluetooth pair button
- ⑨ LCD display
- ⑩ Info button
- ⑪ Menu button
- ⑫ Bluetooth status indicator
- ⑬ Charging/Low battery indicator
- ⑭ Tuning control/Select
- ⑮ Source button
- ⑯ Power button
- ⑰ Speaker
- ⑱ Auxiliary input socket
- ⑲ DC in socket
- ⑳ USB charging socket
- ㉑ Battery compartment
- ㉒ Rod antenna
- ㉓ Socket for software upgrade
- ㉔ NiMH/Alkaline batteries switch

GB

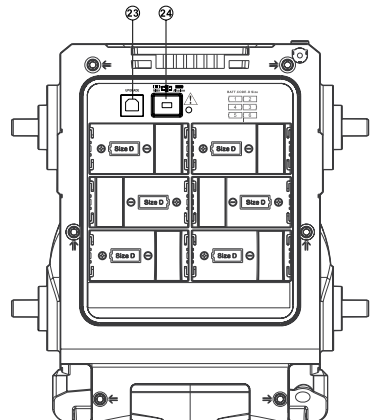
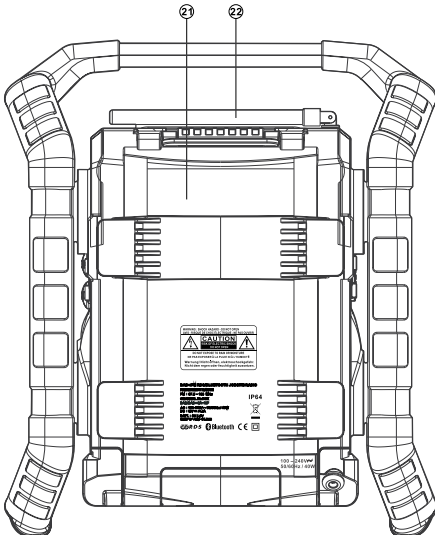

# LCD Display

- Ⓐ Sleep indicator
- Ⓑ Volume indicator
- Ⓒ AM/PM time indicator
- Ⓓ Clock digits
- Ⓔ FM mode indicator
- Ⓕ DAB mode indicator
- Ⓖ Aux in indicator
- Ⓗ Two line text display
- Ⓘ Alarm 1 and 2 indicator
- ⓵ Snooze indicator

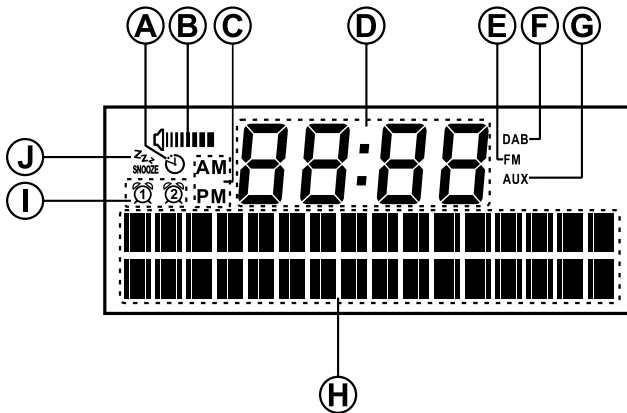



# Power the radio

GB

## 1. Battery operation

**Note:** No batteries are included with this radio.

Pull out the battery compartment locker to release battery compartment. Insert 6 x D size (UM-1) battery into the compartment. Ensure the battery is inserted in accordance with the diagram shown.

Return the battery locker to the original position. If the radio is not to be used for any extended period of time, it is recommended that the battery is removed from the radio.

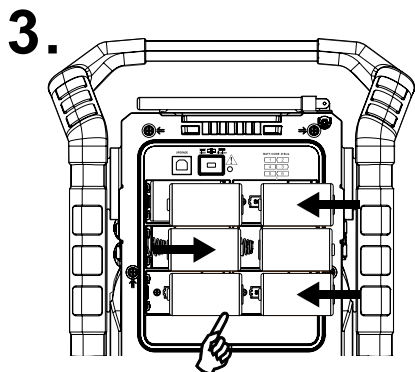
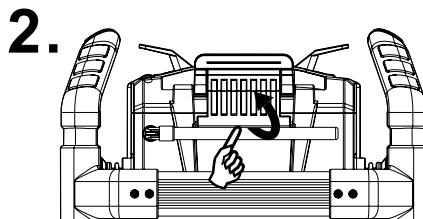
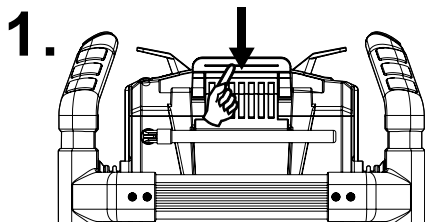

- **Battery operation using alkaline batteries**

1. Before you insert the batteries, if you use non-rechargeable batteries, make sure the NiMH/Alkaline switch which is located inside the battery compartment is switched to Alkaline position. If you use rechargeable batteries, make sure to switch NiMH/Alkaline switch to NiMH position.
2. Reduced power, distortion and a “stuttering sound” are all signs that the batteries need replacing.

- **Battery operation using rechargeable batteries**

1. Slide the battery switch to the NiMH position.
2. Insert 6 UM-1 batteries into spaces in the compartment. Make sure all batteries are inserted with the correct polarity as shown on the rear cabinet. The radio is also designed to be used with NiMH rechargeable batteries.

**Note:**

Do not use a mix of old and new rechargeable batteries.

Do not use a mix of full and empty rechargeable batteries.

Do not use batteries that have a different mAh capacity

Do not use damaged or leaking batteries

3. Make sure the radio is switched off and connected to the AC mains socket. When the charge indicator flashes yellow indicating batteries are charging. Batteries will be fully charged in around 10 hours. The battery shows steady yellow light when the battery charging is complete.

**Note:**

Duration for charging your battery fully can be varied according to the mAh capacity of a battery. Higher mAh batteries required longer charging time.

**Important:**

Under some conditions the charging LED indicator may switch off after flashing briefly. This may happen if the batteries are already freshly charged, or if the radio detects that you may be attempting to recharge alkaline batteries or mixed different types or capacity of rechargeable battery. In these cases the charging will be stopped.

**2. AC operation**

Before you plug the AC cord into the AC socket, be sure the voltage is correct. If you have batteries in the radio and use the AC power cord, the batteries will automatically be disconnected. AC cable hook is designed to store the cord when the radio is not in use.

**Important:**

The mains plug is used as the means of connecting the radio to the mains supply. The mains socket used for the radio must remain accessible during normal use. In order to disconnect the radio from the mains completely, the mains plug should be removed from the mains outlet completely.

**3. Powered via DC IN socket**





The radio can be also powered via the DC IN socket which can allow 12 Volt DC, which is designed to be powered by the vehicle or the boat so you can take the radio with you outdoors or on the boat.

An additional cigarette lighter cable is required (not supplied) for this device.

**Note:** Never use the 12 Volt socket in rainy or moist conditions to prevent moist from entering the radio. Always keep the rubber cover on the back well closed under these conditions.

## Battery charging status indicator

Please note that the battery charging status detection can only be activated when the radio is in charging mode (i.e. the radio is switched off, the battery switch slides to the NiHM position and it is connected to the AC mains socket).

|   |   |
|---|---|
| <p><b>When charging is in progress</b>, display is shown at right and the charging indicator flashes yellow.</p>  |  <p>14:21<br/>Battery 123456<br/>Charge time ■■■■■■</p> |
| <p><b>When the charging process is completed</b>, display is shown at right and the charging indicator lights in steady yellow.</p>   |  <p>00:00<br/>Battery 123456<br/>Capacity ■■■■■■</p>    |
| <p><b>If batteries are already fully charged</b>, display is shown at right and it will switch to standby mode after 5 seconds.</p>   |  <p>14:22<br/>Battery Full</p>                          |
| <p><b>When there is no battery/missing batteries in the compartment or some of batteries are inserted with the incorrect polarity</b>, display is shown at right and it will enter standby screen after 5 seconds.</p> <p><b>Note:</b> If a battery is removed while charging, display is shown at right and the charging indicator lights red.</p> |  <p>14:21<br/>No cell</p>                             |

During the charging process, **if a battery is detected as faulty/damaged**, a solid square will be displayed under the corresponding battery number (see picture, right) and the charging indicator flashes red.



## Using DAB for the first time- DAB

1. Straighten up the antenna.
2. Press the Power button to switch on the radio. If the radio has been used before the last used mode will be selected.
3. Press and release the Source button to select DAB mode. The display will show DAB for a few seconds.
4. If this is the first time the radio is used a quick scan of the DAB Band III channels may be carried out. The display will show 'Scanning' (If the radio has been used before the last used station will be selected instead.)

During the scanning process, as new stations are detected the station counter will increase and the stations will be added to the list which is stored in the radio. The bar graph indicates the progress of the scan.

5. When scanning is completed the radio will list the stations found (in numeric-alpha order 0...9...A...Z), unless it has previously been tuned to a DAB station.

Rotate the Tuning control to scroll through the list of available DAB radio stations.

Press the Tuning control to select the highlighted station. The display may show 'Connecting...' while the radio re-tunes.

When a DAB station is found, the display will show the station name on the upper line of the text display and broadcast information on the lower line.

Use the Volume control to set the sound level as needed.

6. If the station list is still empty after the scan the display will show 'No DAB Station' then return to the DAB menu. If no stations are found it may be necessary to relocate your radio to a position giving better reception.

## Selecting a station- DAB

GB

1. When playing a DAB radio station, the display normally shows the name of the current station with other related information.
2. Rotate the Tuning control to access the radio station list and to scroll through the available stations.
3. Press the Tuning control to select the desired station. The display may show 'Connecting...' while the radio re-tunes.
4. Use the Volume control to set the sound level as needed.

### **Note:**

If the display shows 'Service Not Available' it may be necessary to relocate your radio to a position giving better reception.

A question-mark in front of the station name merely indicates that the station has not recently been detected by the radio. It may still be available.

## Secondary services - DAB

1. Certain radio stations may have one or more secondary services associated with them. If a station has a secondary service associated with it the display will show ">>" next to the station name on the station list. The secondary service will then appear immediately after the primary service as you press the Tuning control.
2. Press and release the Tuning control to select the station. Most secondary services do not broadcast continually and if the selected service is not available, the radio will re-tune to the associated primary service

## Display modes

Your radio has a range of display options when in DAB mode:-

1. Press the Info button to cycle through the different options.

- |                             |  |
|-----------------------------|--|
| a. Text                     | Displays text messages such as the artist or track name, phone in number, traffic alerts, etc.   |
| b. Program Type             | Displays the type of station being listened to such as Pop, Classic, News etc.   |
| c. Multiplex Name/Frequency | Displays the name of the DAB multiplex to which the current station belongs as well as its broadcast frequency.  |
| d. Time & Date              | Displays the current Time & date.  |
| e. Frequency & channel      | Displays frequency and channel number for the currently tuned DAB station.   |
| f. Bit rate and audio type  | Displays the digital bit rate and audio coding information for the station being listened to.  |
| g. Signal error/strength    | Displays the signal error and strength for the station being listened to. A lower error number indicates a better quality of radio signal. The signal strength graph can be used when positioning the radio or its antenna. For good reception the graph should occupy three or more blocks. |



## Finding new stations - DAB

From time to time, new DAB radio stations may become available. Or you may have moved to a different part of the country. In this case you may need to cause your radio to scan for new stations.

1. Press and release the Menu button until the Advanced DAB menu shows on the display.
2. Rotate the Tuning control until 'Full scan' is shown on the display.
3. Press the Tuning control to initiate the scan. The display will show 'Scanning' and your radio will perform a scan of the DAB Band III frequencies. As new stations are found the station counter will increase and stations will be added to the list. The bar graph indicates the progress of the scan.
4. Alternatively press Auto tune button to scan for new stations.

## Manual tuning - DAB

Manual tuning allows you to tune your radio to a particular DAB frequency in Band III. Any new stations found will be added to the station list. This function can also be used to assist the positioning of the antenna or the radio to optimize reception for a specific channel or frequency.

1. Press and release the Menu button until the Advanced DAB menu shows on the display.
2. Rotate the Tuning control until the display shows 'Manual tune'.
3. Press and release the Tuning control to enter the manual tuning mode.
4. Rotate the Tuning control to select the desired DAB channel.
5. Press and release the Tuning control. The open block in the signal strength graph shows the minimum signal strength needed for good DAB reception. The signal blocks will go up and down showing the changing signal strength as you adjust the antenna or the radio position. Any new radio stations found on the tuned DAB multiplex will be added to the list stored in the radio.
6. Press and release the Tuning control to return to normal tuning mode.

## Dynamic Range Control (DRC) - DAB

The DRC facility can make quieter sounds easier to hear when your radio is used in a noisy environment.

There are three levels of compression:

DRC Off No compression applied. (default)

DRC High Maximum compression applied.

DRC Low Medium compression applied.

1. Press the Power button to switch on your radio.
2. Press and release the Source button until the DAB band is selected.
3. Press and release the Menu button until the Advanced DAB menu shows on the display.
4. Rotate the Tuning control until 'DRC ' appears on the display. Press and release the Tuning control. The display will show the current DRC value which will be marked with an asterisk.
5. Rotate the Tuning control to select the required DRC setting (default is off).
6. Press and release the Tuning control to confirm the setting. After several seconds the display will return to the normal radio display.

### **Note:**

Not all DAB broadcasts are able to use the DRC function. If the broadcast does not support DRC, then the DRC setting in the radio will have no effect.

## Station order setup

Your radio has 2 station order settings from which you can choose. The station order settings are, alphanumeric and ensemble.

**Note:** The default station order on your radio is ensemble.

1. Press the Power button to switch on your radio.
2. Press the Source button as needed to select DAB radio mode.
3. Press the Menu button to enter the Advanced DAB menu shows on the display.
4. Rotate the Tuning control until 'Station order' is shown on the display.
5. Press the Tuning control to enter the station order adjustment mode.
6. Rotate the Tuning control to choose between 'Alphanumeric' and, 'Ensemble' .

'Alphanumeric' - sorts the station list alpha-numerically 0...9 A...Z.

'Ensemble' - organizes the station list by DAB multiplex.

The current setting is indicated by an asterisk.

7. Press the Tuning control to select the required station order.

## Prune stations - DAB

GB

Over time, some DAB services may stop broadcasting, or may change location and then not be able to receive a station. In order to remove such stations from the DAB station list, the Prune stations function will delete the DAB stations from your station list that can no longer be received.

Stations which cannot be found or which have not been received for a very long time are shown in the station list with a question mark.

1. Press the Power button to switch on your radio.
2. Press and release the Source button until the DAB mode is selected.
3. Press and release the Menu button until the Advanced DAB menu shows on the display.
4. Rotate the Tuning control until 'Prune' appears on the display. Press and release the Tuning control to enter the setting.
5. Rotate the Tuning control to highlight 'Yes'. Press and release the Tuning control to cause the stations list to be pruned, eliminating unavailable stations.
6. If you do not wish to prune stations highlight 'No' in step 5 and then press and release the Tuning control. The display will revert back to the previous display.

### **Note:**

If you have moved to a different part of the country you should also carry out a search for new stations (please see the section 'Finding new stations' in the previous section).

## Operating your radio - FM auto-tune

1. Straighten up the antenna.
2. Press the Power button to switch on your radio.
3. Press and release the Source button until the FM band is selected.
4. Press and release the Auto tune button to cause your radio to search from low frequency to high frequency and to stop automatically when it finds a station of sufficient strength.
5. After a few seconds the display will update. The display will show the frequency of the signal found. If the signal is strong enough and there is RDS data present then the radio may display the station name.
6. To find other stations press the Auto tune button as before. When the end of the waveband is reached, your radio will recommence tuning from the opposite end of the waveband.
7. Adjust the Volume to the required setting.
8. To switch off your radio, press the Power button.

**Note:**

If you find that FM reception is poor, try repositioning the antenna.

## Manual tuning - FM

GB

1. Straighten the antenna.
2. Press the Power button to switch on your radio.
3. Press and release the Source button until the FM band is selected.
4. Rotate the Tuning control to tune to a station. The frequency will change in steps of 50kHz. If the radio is tuned to a station of sufficient signal strength with RDS information present, then the display may change to show the station name.
5. When the waveband end is reached the radio will recommence tuning from the opposite waveband end.
6. Set the Volume to the desired setting.

## Display options - FM

Your radio has a range of display options for FM mode:-

The Radio Data System (RDS) is a system in which inaudible digital information is transmitted in addition to the normal FM radio programme. RDS offers several useful features. The following are available on your radio.

1. Press and release the Info button to cycle through the various options.

- |                   |   |
|-------------------|---|
| a. Scrolling text | Displays scrolling text messages such as artist/track name, phone in number, etc. |
| b. Programme type | Displays type of station being listened to e.g. Pop, Classic, News, etc.          |
| c. Multiplex name | Displays the name of the FM multiplex to which the current stations belongs.      |
| d. Audio type     | Displays the audio type for the currently tuned FM station.                       |
| e. Time           | Displays the current time.  |
| f. Date           | Displays the current date.  |

### **Note:**

If no RDS information is available, the radio will be unable to display the station name, scrolling text and programme type information.



## Scan sensitivity setting - FM

GB

Your radio includes a local/distant option for the auto-scan function. By setting the radio to the 'local' scan option, weaker signals from more distant transmitters can be ignored by the radio, making stronger signals easier to find.

1. Press and release the Power button to switch on your radio.
2. If needed, press and release the Source button until the FM band is selected.
3. Press and release the Menu button until the Advanced FM menu shows on the display.
4. Rotate the Tuning control until 'FM Scan Zone' shows on the display. Press and release the Tuning control to enter the scan sensitivity adjustment mode. The current setting will be marked with an asterisk.
5. Rotate the Tuning control to switch between 'Local' (Strong stations only) and 'Distant' (All stations) options on the lower line of the display. The Distant option will allow the radio to find weaker signals when scanning
6. Press and release the Tuning control to confirm your selection. The Local or Distant setting is stored in the radio and remains in force until changed or until a System Reset.

## Presetting stations - DAB and FM

You may store your preferred DAB and FM radio stations to the preset station memories. There are 10 memory presets in your radio 5 for DAB and 5 for FM. Presets are memorized by your radio in the event of a power failure.

The procedure for setting presets and using them to tune stations is the same for FM and DAB mode, and is described below.

1. Press the Power button to switch on the radio.
2. Press the Source button to select the DAB or FM waveband.
3. Tune to the required station as previously described.
4. Press and hold the Preset button until the display shows, such as, 'Preset 1 stored.' The station will be stored under the chosen preset button. Repeat this procedure as needed for the remaining presets. Stations stored in preset memories may be overwritten by following the above procedure.

## Recalling a preset station- DAB and FM

1. Press the Power button to switch on the radio.
2. Press and release the required waveband by pressing the Source button.
3. Press and release the required Preset button to cause your radio to tune to the station stored in preset memory.

### **Note:**

The display will show 'Preset Empty' if no station has been stored to that preset.

## Listening to music via Bluetooth streaming

GB

You need to pair your Bluetooth device with your radio before you can auto-link to play/stream Bluetooth music through your WORK-XL1. Pairing creates a 'bond' so two devices can recognize each other.

### Pairing your Bluetooth device for the first time

1. Press the Power button to switch on the radio.
2. Press the Source button to select the Bluetooth mode.

The Bluetooth status indicator (  ) on the panel flashes blue to show the radio is discoverable.

3. Activate Bluetooth on your device according to the device's user manual to link to the speaker. Locate the Bluetooth device list and select the device named 'WORKXL1\_CAL'. With some mobiles (which are equipped with earlier versions than BT2.1 Bluetooth device, you may need to input the pass code "0000").
4. Once connected, the Bluetooth icon will remain in solid blue. You can simply select and play any music from your source device. Volume control can be adjusted from your source device, or directly on your radio.



#### Note:

- 1) If 2 Bluetooth devices, pairing for the first time, both search for your radio, it will show its availability on both devices. However, if one device links with this unit first, then the other Bluetooth device won't find it on the list.
- 2) If you take your source device out of range, the connection will be temporarily disconnected to your radio. Your radio will automatically reconnect if the source device is brought back in range. Be aware that during the period of disconnection, no other Bluetooth device can pair or link with your radio.

- 3) If 'WORKXL1\_CAL' shows in your Bluetooth device list but your device cannot connect with it, please delete the Caliber WORKXL1\_CAL item from your list and pair the device with the speaker again following the steps described previously.
- 4) The effective operation range between the system and the paired device is approximately 10 meters (30 feet). Any obstacle between the system and the device can reduce the operational range.
- 5) Bluetooth/NFC connectivity performance may vary depending on the connected Bluetooth devices. Please refer to the Bluetooth capabilities of your device before connecting to your radio. All features may not be supported on some paired Bluetooth devices.

### **Playing audio files in Bluetooth mode**

When you have successfully connected your radio with the chosen Bluetooth device you can start to play your music using the controls on your connected Bluetooth device.

1. Once playing has started adjust the volume to the required setting using the Volume control on your radio or on your enabled Bluetooth device.
2. Use the controls on your device to play/pause and navigate tracks. Alternatively, control the playback using Play/Pause , Next track , Previous track  buttons on the radio.

### **Note:**

- 1) That not all player applications or devices may respond to all of these controls.
- 2) Some mobile phones may temporarily disconnect from your radio when you make or receive calls. Some devices may temporarily mute their Bluetooth audio streaming when they receive text messages, emails or for other reasons unrelated to audio streaming. Such behaviour is a function of the connected device and does not indicate a fault with your radio.

## **Pairing a different device to your radio**

Before pairing another device to the speaker, you need to make the radio discoverable.

1. Press and hold the Bluetooth pair button to make the radio discoverable again and the Bluetooth status indicator flashes.
2. Follow step3-4 in the previous section of 'Pairing your Bluetooth device for the first time.

## **Playing previously-paired devices**

This unit can memorize up to 8 sets of paired device, when the memory exceed this amount, the earliest paired device will be over written.

If your Bluetooth device already paired with the speaker previously, the unit will memorize your Bluetooth device and it attempts to re-connect with a device in memory which is last connected. If the last connected device is not available, the speaker will be discoverable.

Alternatively, you can select your required Bluetooth device in the memory, as following:

Press and release the Bluetooth pair button to enter the Bluetooth device memory. Then rotate the Tuning control to find the desired memorized Bluetooth device and press the Tuning control to connect to the required Bluetooth device.

Alternatively, repeatedly press and release the Bluetooth pair button to have access to the stored Bluetooth device and press the Tuning control to connect to the required Bluetooth device.

## **Disconnecting your Bluetooth device**

Press the Source button to select any bands other than Bluetooth band. Alternatively, press and hold the Bluetooth pair button to disconnect the link.

If you disconnect the Bluetooth device when you are in Bluetooth mode, the LED light for Bluetooth icon will then start to flash indicating Bluetooth is discoverable again for pairing.

## Pairing and playing your device via NFC

WORKXL1 is equipped with wireless NFC (Near Field Communication) feature, allowing playing NFC-enabled devices to pair and play the music. For non-NFC devices, please refer to the above sections for standard Bluetooth pairing.

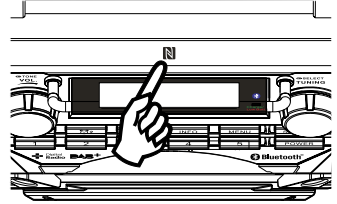

1. Turn on your NFC feature on your device. (**Important:** Please make sure the screen of your playing device is **on and unlocked** to allow NFC to work.)
2. Touch the NFC area of your playing device against the NFC area marked on top panel of WORKXL1. The unit will turn on and enter automatic pairing mode. If you pair with WORK XL1 for the first time, your NFC-enabled device will be asked the permission to link with the radio. Once paired with a device, the Bluetooth icon will remain illuminated.
3. Use the controls on your device or on your radio to play/pause and navigate tracks.

### Note:

1. If you would like to link a different Bluetooth device for the first time via NFC, disconnect the currently-linked Bluetooth device first.
2. The location of the NFC detection area is not the same on all devices. When connecting with other Bluetooth device via NFC, refer to the User guide of your Bluetooth device for more information.
3. Some of metallic case or cover for mobile phones may reduce the sensitivity of NFC. Make sure you remove it, before activating the NFC.

## Disconnecting your NFC-enabled device

To disconnect your device, simply touch it again on the top of the unit. The LED light for Bluetooth icon will then start to flash indicating your radio is discoverable again for pairing.

(**Important:** Please make sure the screen of your playing device is **on and unlocked** to allow NFC to work.)

# Alarms

Your radio has 2 separate alarms which can be set to wake you to DAB, FM radio or buzzer alarm. Each alarm can be set to sound once, daily, on weekdays or at weekends. The alarms can be set whether the radio is on or in standby mode. In the event of a power interruption your radio has a built in memory chip that will maintain your alarm settings for when the power is restored.

## Note:

If no buttons are pressed for a while, the radio will exit the alarm setup.

## Setting an alarm

1. Press and release the Alarm 1 button to enter the setting, 'Alarm 1 Setup' will show on the display and alarm 1 icon  will flash on the display. Or press and release the Alarm 2 button to enter alarm 2 setting.
2. Press the Tuning control to enter the setting menu.
3. Rotate the Tuning control to select On or Off. If Off is selected any current setting for that alarm will be cancelled. With 'On' selected, press and release the Tuning control to cause the alarm hour digits to flash on the display.
4. Rotate the Tuning control to choose the desired hour for the alarm and then press the Tuning control to cause the alarm minute digits to flash on the display.
5. Rotate the Tuning control to choose the desired minute for the alarm and then press the Tuning control. The alarm duration will flash on the display. If the radio has been set to the 12 hour clock format, there will also be an option here for setting AM or PM for the alarm time

6. Rotate the Tuning control to choose the alarm duration. Choose between 15, 30, 45, 60 or 90 minutes. Press and release the Tuning control to confirm the alarm duration.
7. The alarm source option will flash on the display. Rotate the Tuning control to choose the desired source for the alarm (DAB, FM, Buzzer). Press the Tuning control when the desired source alarm is shown on the display. For which ever radio mode is selected, the radio alarm may be set to any of the stations which have been stored as presets or to the station last listened to.
8. Press and release the Tuning control to confirm the selection. The alarm day option will flash on the display.
9. Your alarm can be set to sound once, daily, weekdays and weekends.  
Once - Will sound at one time only.  
Daily - Will sound every day.  
Weekdays - Will sound only on weekdays.  
Weekends - Will sound only on weekends.
10. Rotate the Tuning control to choose the day option and then press and release the Tuning control to confirm the setting.
  - \* If setting alarms to daily, weekdays or weekends proceed to point 14.
  - \* If selecting the alarm to once you will need to set the day, month and year options as described from step 11-13.



11. Rotate the Tuning control to select the correct day and then press the Tuning control to confirm the setting.
12. Rotate the Tuning control to select the correct month and then press the Tuning control to confirm the setting.
13. Rotate the Tuning control to select the correct year and then press the Tuning control to confirm the setting.
14. Rotate the Tuning control to choose the desired volume and press the Tuning control to confirm the setting. Your radio will show 'Alarm Saved' and will exit the alarm setting procedure.

**Note:**

Active alarms are indicated in the display by the alarm symbol (e.g. ). If the radio cannot connect to the radio station, buzzer alarm will be used instead. The alarm will sound for the selected duration unless cancelled.

**Cancelling alarms**

1. While an alarm is sounding, it can be cancelled by pressing the Power button.
2. To cancel the alarm before going off, enter the alarm setting wizard and set the alarm On/Off option to 'Off' (Please refer to previously described 'setting an alarm' section). Alternatively, press the required alarm button and rotate the Tuning control to select 'off.'

## Snooze

1. When the alarm sounds, press any button other than the Power button will silence the alarm for 5 minutes. Remaining snooze time will show on the display.
2. You can also select your required snooze time, as following:
  - a. Access the menu for the current mode by pressing the Menu button.
  - b. Rotate the Tuning control until 'System ' appears on the display. Press and release the Tuning control.
  - c. Rotate the Tuning control until 'Snooze Duration' appears on the display. Press and release the Tuning control.
  - d. Rotate the Tuning control to select the desired snooze time. The options are 5, 10, 15, 20 minutes.
3. To cancel the snooze time while the alarm is suspended, press the Power button.

## Sleep function

Your radio can be set to turn off after a preset time has elapsed. The sleep setting can be adjusted between 15, 30, 45, 60, 90 and 120 minutes.

1. Access the menu for the current mode by pressing the Menu button.
2. Rotate the Tuning control until 'Sleep' is shown on the display. Press the Tuning control to enter the setting menu.
3. Rotate the Tuning control to select the desired sleep time. The options are 15, 30, 45, 60, 90, or 120 minutes. Use the OFF option to cancel the sleep function.
4. Your radio will switch off after the preset sleep time has elapsed.
5. To cancel the sleep function before the preset time has elapsed, either set the sleep timer to off (step 1-3) or press the Power button.

## Automatically updating the clock

1. Press the Power button to switch on your radio.
2. Press and release the Menu button until the Advanced menu of the current mode shows on the display.
3. Rotate the Tuning control until 'System ' appears on the display. Press and release the Tuning control.
4. Rotate the Tuning control until 'Time' appears on the display. Press and release the Tuning control.
5. Rotate the Tuning control until 'Auto update' appears on the display. Press and release the Tuning control.
6. Rotate the Tuning control to choose an update option from 'Update from Any', 'Update from DAB', 'Update from FM' or 'No update' as required. The current update option will be marked with an asterisk. Press and release the Tuning control to confirm your choice. The radio will exit to the previous menu.

### **Note:**

If you select 'Update from Any', 'Update from DAB', 'Update from FM' the current time received will be displayed. If no signal is found you should either position the radio or its antenna so that a signal can be received, or revert to manual clock mode.

## Setting the clock manually

Your radio will set its clock automatically using the DAB or FM radio signal. If no signal is available and you need to set the time manually, please follow the procedure shown below.

1. Press the Power button to switch on your radio.
2. Press and release the Menu button until the Advanced menu of the current mode shows on the display.
3. Rotate the Tuning control until 'System ' appears on the display. Press and release the Tuning control.
4. Rotate the Tuning control until 'Time' appears on the display. Press and release the Tuning control.
5. Rotate the Tuning control until 'Set Time/Date' appears on the display.
6. Press and release the Tuning control. The hour digits will flash on the display.
7. Rotate the Tuning control to set the desired hour. Press and release the Tuning control.
8. The minute digits will flash on the display. Rotate the Tuning control to set the desired minute. Press and release the Tuning control.
- If the radio has been set to use a 12 hour format, there will be an option here for setting AM or PM for the clock time.
9. The day will flash on the display. Rotate the Tuning control to change the day as needed. Press and release the Tuning control.
10. The month will flash on the display. Rotate the Tuning control to set the current month. Press and release the Tuning control.
11. The year will flash on the display. Rotate the Tuning control to set the current year. Press and release the Tuning control to confirm the clock setting. The display will show 'Time Saved' then exit the menu.

## Setting the time format

The display used in standby mode and when the radio is in use can be set to 12 or 24 hour format. The selected format is then also used when setting the alarms.

1. Press the Power button to switch on your radio.
2. Press and release the Menu button until the Advanced menu of the current mode shows on the display.
3. Rotate the Tuning control until 'System ' appears on the display. Press and release the Tuning control.
4. Rotate the Tuning control until 'Time' appears on the display. Press and release the Tuning control.
5. Rotate the Tuning control until 'Set 12/24 hour' appears on the display. Press and release the Tuning control.
6. Rotate the Tuning control to select either 12 or 24 hour format. The current hour format will be marked with an asterisk. Press and release the Tuning control. If the 12 hour clock format is chosen, the radio will then use the 12 hour clock for setting of alarms, and will display a 12 hour clock with an AM or PM indicator.

## Setting the date format

GB

1. Press the Power button to switch on your radio.
2. Press and release the Menu button until the Advanced menu of the current mode shows on the display.
3. Rotate the Tuning control until 'System ' appears on the display. Press and release the Tuning control.
4. Rotate the Tuning control until 'Time' appears on the display. Press and release the Tuning control.
5. Rotate the Tuning control until 'Set date format' shows on the display. Press and release the Tuning control.
6. Rotate the Tuning control to select your desired date format. The current format will be marked with an asterisk. Press and release the Tuning control.

## Language function

Your radio can be configured to a different language.

1. Press the Power button to switch on your radio.
2. Press the Menu button until the Advanced menu of the current mode shows on the display.
3. Rotate the Tuning control until 'System ' appears on the display. Press and release the Tuning control.
4. Rotate the Tuning control until 'Language' appears on the display.
5. Press and release the Tuning control to enter the language adjustment menu.
6. Rotate the Tuning control until your desired language appears on the display.
7. Press and release the Tuning control to confirm your choice. The display will change to the chosen language.



## Equalizer function

The sound of your sound system can be adjusted to suit your personal taste for the material that you are listening to. Your radio has six preset equalizer modes. Alternatively, you may set the treble and bass levels to your own preferences.

1. Press the Volume control and rotate the Tuning control to cycle through the various modes. Press the Tuning control to confirm the option.
  - a. My EQ (Treble/Bass - tone setting may be adjusted/Loudness-on/off may be adjusted)
  - b. Normal-no tone modification is applied
  - c. Classic
  - d. Jazz
  - e. Pop
  - f. Rock
  - g. Speech

## Set up my EQ profile

If you find the preset equalizer functions not to your liking, you may set up a custom treble and bass as following:

1. Press the Volume control to enter EQ menu.
2. Rotate the Tuning control until 'My EQ' is shown on the display. Press the Tuning control to enter the adjustment mode.
3. Rotate the Tuning control until 'Treble' is shown on the display. Press the Tuning control to enter the treble adjustment mode.
4. Rotate the Tuning control to adjust the treble level (between -5 and +5). The sound will change as you adjust the level. Press the Tuning control to confirm the setting. The display will then revert to My EQ menu.
5. Rotate the Tuning control until 'Bass' is shown on the display. Press the Tuning control to enter the adjustment setting. Rotate the Tuning control until the desired level (between -5 and +5) is displayed. The sound will change as you adjust the level. Press the Tuning control to confirm the setting.
6. Rotate the Tuning control until 'Loudness' is shown on the display. Press the Tuning control to enter the adjustment setting. Rotate the Tuning control to select the desired setting. The options are On or Off.. the default is Off. Then press the Tuning control to confirm the setting.

### **Note:**

To quickly cancel the effect of My EQ profile, rotate the Tuning control until 'Normal' is shown on the display and press the Tuning control. The treble and bass settings will be memorized for the next time that you wish to use the My EQ.

## Software version

GB

The software display cannot be altered and is just for your reference.

1. Press the Power button to switch on your radio.
2. Press the Menu button until the Advanced menu of the current mode shows on the display.
3. Rotate the Tuning control until 'System ' appears on the display. Press and release the Tuning control.
4. Rotate the Tuning control until 'SW Version' appears on the display.
5. Press and release the Tuning control. The software version shows on the display.
6. Press and release the Menu button to exit the software version display.

## Software upgrades

Software updates for your radio may be available in the future. Check our website for updates.

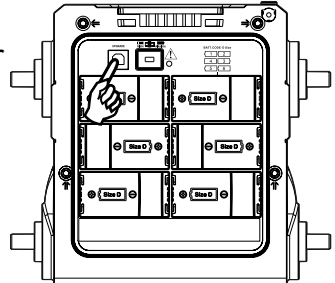

1. Plug the USB into the USB socket in the battery compartment.
2. Press the Menu button to enter the Advanced menu of the current mode.
3. Rotate the Tuning control until 'System ' appears on the display. Press and release the Tuning control.
4. Rotate the Tuning control until 'Software Upgrade' appears on the display. Press and release the Tuning control.
5. Rotate the Tuning control until 'Yes' is highlighted on the display. If you do not wish to carry out a software upgrade, highlight 'No' and then press the Tuning control. The display will revert back to the previous display.

## System reset

GB

If your radio fails to operate correctly, or some digits on the display are missing or incomplete carry out the following procedure.

1. Press the Power button to switch on your radio.
2. Press the Menu button until the Advanced menu of current mode shows on the display.
3. Rotate the Tuning control until 'System ' appears on the display. Press and release the Tuning control.
4. Rotate the Tuning control until 'Factory Reset' appears on the display. Press and release the Tuning control.
5. Rotate the Tuning control until 'Yes' is highlighted on the display and press and release the Tuning control. A full reset will be performed. The station list and presets will be erased. Alarms will be cancelled and sleep timer settings will be set to their default values. The display will show 'Welcome to Digital Radio' and the unit will behave as when first switched on.

If you do not wish to carry out a system reset, highlight 'No' and then press the Tuning control. The display will revert back to the previous display.

In case of malfunction due to electrostatic discharge, reset the product using the above procedure. In some circumstances it may be necessary to disconnect and then reconnect the mains power in order to resume normal operation.

## Setting the Backlight timeout

Your radio can be set to timeout the backlight. The backlight timeout setting can be adjusted between **ON, 10, 20, 30, 45, 60, 90, 120 and 180** seconds.

1. Access the menu for the current mode by pressing the Menu button.
2. Rotate the Tuning control until 'System ' appears on the display. Press and release the Tuning control.
3. Rotate the Tuning control until 'Backlight' is shown on the display. Press the Tuning control to enter the setting menu.
4. Rotate the Tuning control to select the desired time. The options are on (backlight will be on all the time), 10, 20, 30, 45, 60, 90, 120, or 180 seconds.
5. Your radio will switch off the backlight after the preset time has elapsed.

## Auxiliary input socket

A 3.5mm Auxiliary input socket is provided on the right side of your radio to permit an audio signal to be fed into the unit from an external audio device such as an iPod, MP3 or CD player.

1. Connect a stereo or mono audio source (for example, iPod, MP3 or CD player) to the Auxiliary input socket (marked 'Aux In').
2. Press the Power to switch on your radio.
3. Press the Source button until the Auxiliary Input band is selected.
4. Adjust the Volume control on your iPod, MP3 or CD player to ensure an adequate signal and then adjust the volume on the radio for comfortable listening.

**Note:** Never use the Aux-In socket in rainy or moist conditions to prevent moist from entering the radio. Always keep the rubber cover on the back well closed under these conditions.

## Charging with USB socket

GB

You can use the USB jack charging function by following the procedure below.

1. Press the Power button to switch on your radio.
2. Press and release the Menu button until the Advanced menu of the current mode shows on the display.
3. Rotate the Tuning control until 'System ' appears on the display. Press and release the Tuning control.
4. Rotate the Tuning control until 'USB Charge' appears on the display. Press and release the Tuning control.
5. Rotate the Tuning control to select the desired setting. The options are On or Off.. the default is Off.

### **Note:**

- 1) The USB jack can only provide power for the USB memory stick only with 1A 5V maximum and most of iPhone models. However, it does not support external Hard disk drive, all types of mobile phones and electronic device.
- 2) The maximum volume of the output power speaker will decrease when your USB is charging.

### **Important:**

- 1) Do not connect this USB socket with your PC USB port, as it highly possible may cause breakdown of the unit.
- 2) Never use the USB socket in rainy or moist conditions to prevent moist from entering the radio. Always keep the rubber cover on the back well closed under these conditions.

# Specifications

## Frequency Coverage:

FM 87.50 – 108MHz

DAB 174.928 – 239.2MHz

## AC Power:

AC 100 ~ 240V / 50 / 60Hz / 40W ( Europe )

Batteries: 6 x UM-1 ( D size )

## DC IN:

12V / 1.2 A center pin positive ( operational voltage 9-14V )

5.5 mm in diameter.

## Bluetooth

Bluetooth specification

Bluetooth® Ver 3.0

Profile Support

A2DP, AVRCP1.4

Bluetooth Audio CODEC

SBC, AAC

Transmitting Power

Specification Power Class 1

Line of sight range

10 meters / 30 feet

## Output Power:

4W 10% T.H.D. @ 100Hz @ DC battery 9V

7W 10% T.H.D. @ 100Hz @ AC 230V or 110V

## Aux in socket:

3.5 mm diameter, stereo jack to be mixed as monaural

**Input sensitivity:** 300m Vrms at output 7W @ 1000Hz

**Input impedance:** 47kohm



**DC Out:** USB Socket, 5V 1000mA

**Speaker unit:**

6.5 inches 8 ohm 15W, full range

FM / DAB / DAB + bended spring antenna

**LED illuminator:**

2 x white LED, current consumption 30mA

**Battery life:**

Approx. 36 hours using Alkaline batteries at 500mW output power.

**Dimension:** 298 X 342 X 268

**Weight:** approx. 4.4kgs

*The company reserves the right to amend the specification without notice.*



*If at any time in the future you should need to dispose of this product please note that: Waste electrical products should not be disposed of with household waste. Please recycle where facilities exist. Check with your Local Authority or retailer for recycling advice. (Waste Electrical and Electronic Equipment Directive)*