

RMN 801BT MANUAL
ENGLISH

INSTALLATION

Tools for Installation

Use the 2 removal wrenches of the old unit to take out the old unit and place with this brand new car radio. The following tools and supplies may also be needed for the installation:

Tools for Installation: Philips Screw-drivers /Machine Screws /Wire Stripper /Wire Cutter /Hammer /Pencil /Electrical Tape /Electric Drill

Supplies for Installation: Machine Screws /Crimp Connectors /14 Gauge Wire for Power Connections /14-16 Gauge Speaker Wires

The above are not supplied.

Before you install

Automotive audio equipment installations can be challenging even to the most experienced of installation technicians. We strongly recommend that this unit should be professionally installed by a VAT registered installer (this is a requirement to validate the warranty).

IMPORTANT: Remove the two transport screws from the top of the unit before installing.

Remove the Old Unit from the Dashboard

1. Remove the outer trim frame.

DIN Front Mount

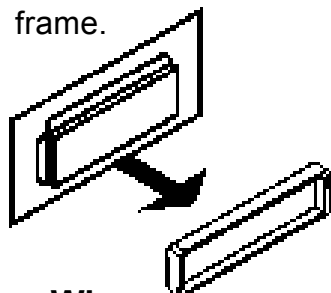

2. Insert the keys supplied with the old unit into both sides of the unit as shown in figure below until they click. Pull to remove the old unit from the dashboard.

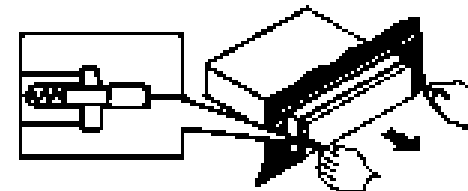

**DO NOT DISCONNECT WIRES
AT THIS TIME!**

Mark Polarity of the Speaker Wires

Marking the polarity of the speaker wires will make it easier to connect the existing speakers to your car radio. Consult wiring diagram of existing head unit before disconnecting any wires. If you are not positive of the polarity of the existing wires from the speakers to the head unit, install new wires.

1. While the old unit is playing, disconnect the wires from one speaker.
 2. Take a length of masking tape and fold it around the wire so it forms a flag.
 3. On the masking tape mark the polarity of the speaker wires (+&-), as well as left or right, and front or rear.
 4. Double check that you marked the first speaker correctly by checking that the speaker wires are the same at the head unit.
 5. Repeat this procedure for all of the speakers.
 6. Mark the power, ground, and any other wires also.
-

INSTALLATION

WARNING: Disconnect negative battery terminal from battery before starting installation. Consult the vehicle's owner's manual for proper instructions.

NOTE: Mark the polarity of the existing speaker wires before disconnecting battery.

NOTE: Remove the two transport screws from the top of the unit before installing.

NOTE: Make sure there is enough space for the installation of this double-din unit.

SUPPLIED TOOLS

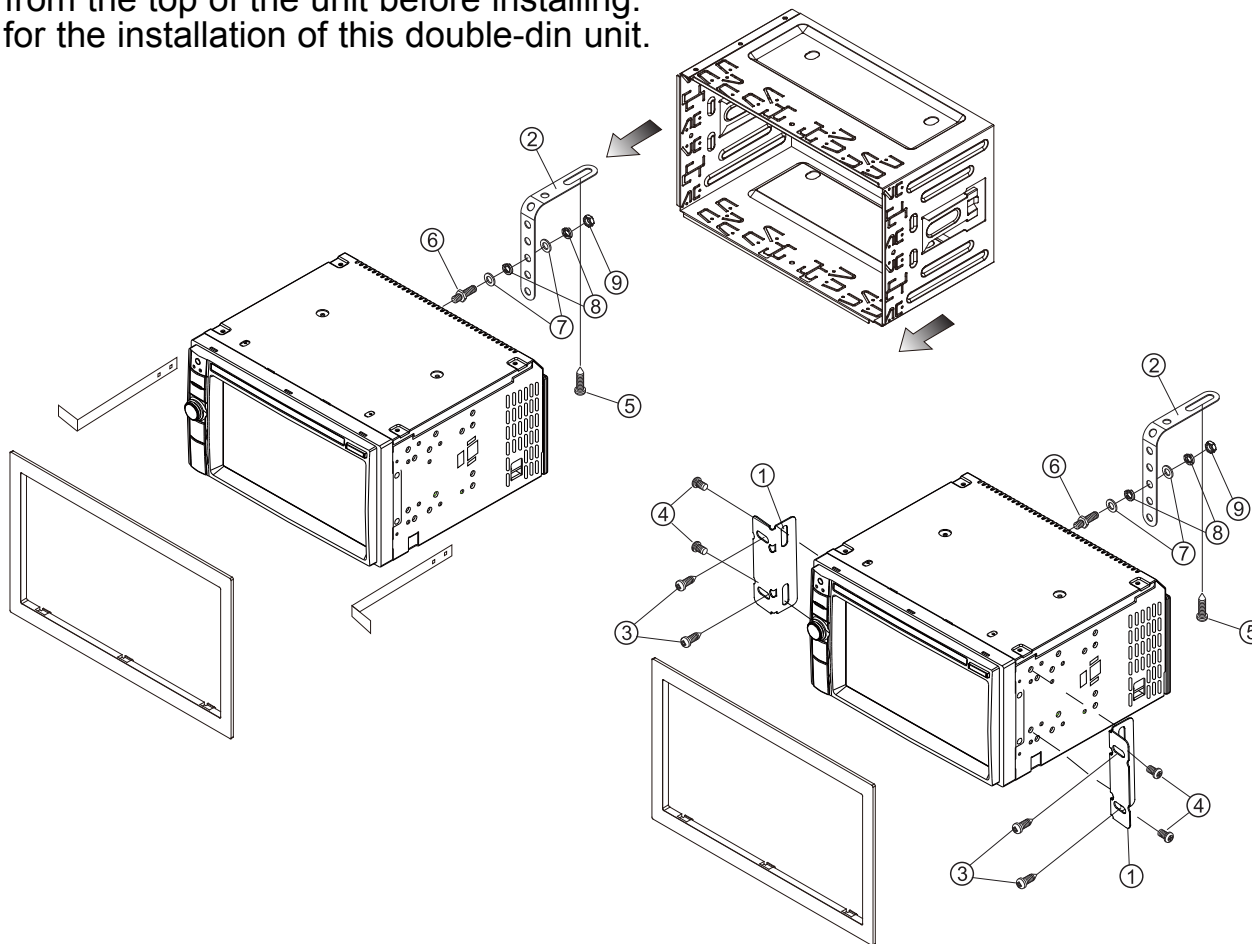
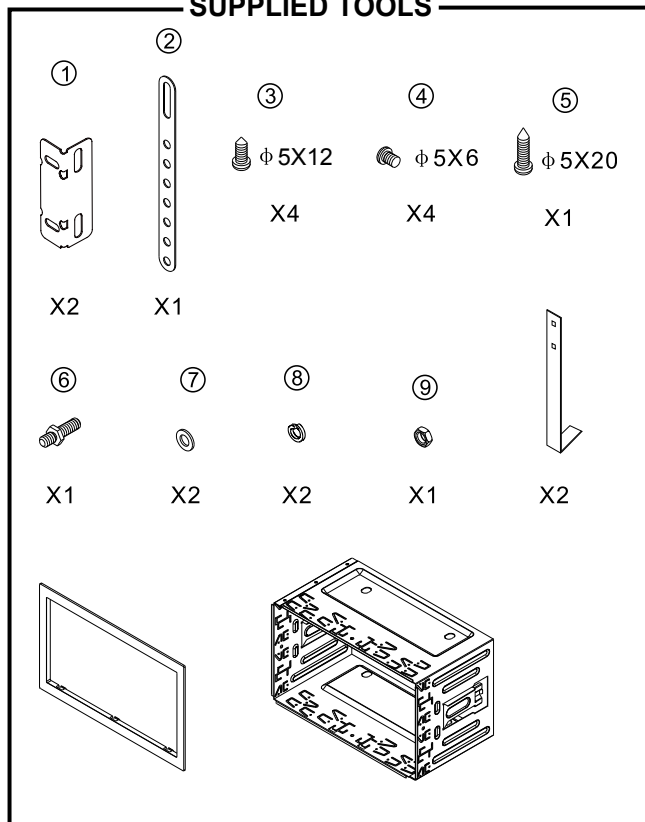

WIRING DIAGRAM

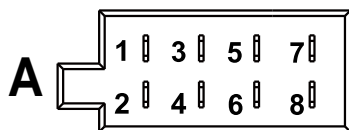
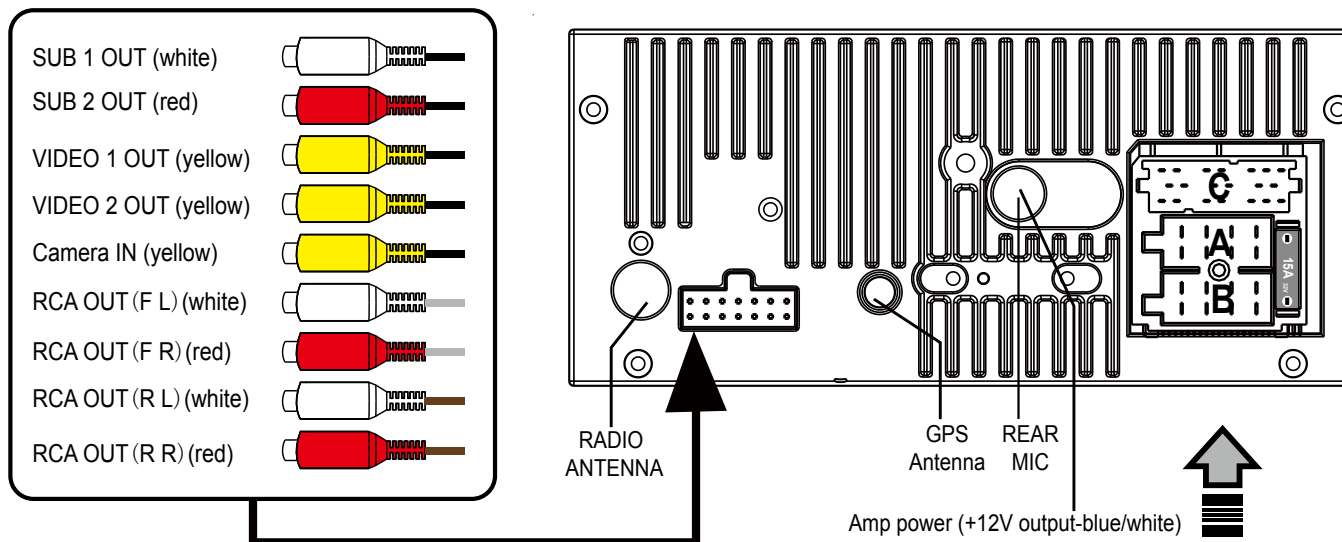

Connector A

1. Rear right speaker(+)/Purple
2. Rear right speaker(-)/Purple-Black
3. Front right speaker(+)/Grey
4. Front right speaker(-)/Grey-Black
5. Front left speaker(+)/White
6. Front left speaker(-)/White-Black
7. Rear left speaker(+)/Green
8. Rear left speaker(-)/Green-Black

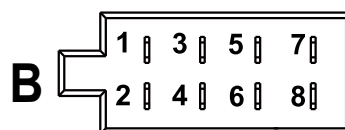

Connector B

1. -
2. -
3. -
4. Battery 12V (+)/Yellow
5. Antenna power/Blue-White
6. -
7. ACC+/Red
8. Ground/Black

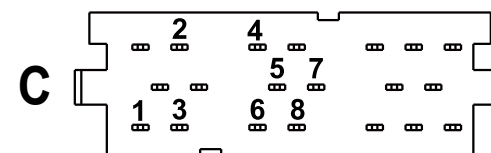

Connector C

1. AUX video in/Yellow (optional)
2. AUX IN (L)/White (optional)
3. AUX IN (R)/Red (optional)
- 4/5/6. SWC
7. Reverse/Purple-White
8. Parking/Green

WIRING DIAGRAM

General Wiring Notes:

Make sure You have a good chassis ground. Good ground connection will eliminate most electrical noise problems. A good chassis ground requires a tight connection to the .vehicle's metal chassis. The area around the ground connection should be clean, bare metal without rust, paint, plastic, dust, or dirt for a good ground connection.

Black Ground

Connect to vehicle body/chassis. Make sure you have a good chassis ground. This will eliminate most electrical noise form the motor and alternator. A good chassis ground requires a tight connection to ground. The area should be free from rust, paint or any form of dirt.

Red Ignition

Connect to car ignition switch for main power supply of the unit.

Yellow Memory Backup

Connect to electrical terminal always supplied with power regardless of ignition switch position.

Blue-White Remote

Connect to Auto-antenna or power amp control wire/remote connection. Maximum current 300mA 12VDC. (Low Current)

Green (Hand Brake - Ground)

Connect this wire to the hand brake wire of your car so that the display will be on only when the car is fully stopped.

Purple-White (Rear Gear - VCC)

Connect this wire to the rear gear wire of your car so that the backup camera function can be activated when you car is in reverse gear.

Various outputs (Refer to the wiring diagram)

Refer to the wiring diagram for the connection details.

Speaker Wiring Notes:

Follow the above wiring diagram to install the head unit with new or existing speakers.

1. This unit is designed for use with four (4) speakers with impedance between 4 Ohms to 8 Ohms.
 2. An Impedance load of less than 4 Ohms could damage the unit.
 3. Never bridge or combine the speaker wire outputs. When not using four speakers, use electrical tape to tape the ends of the unused speaker outputs to prevent a short circuit.
 4. Never ground the negative speaker terminals to chassis ground.
-
-

GENERAL

Operating Power.....12 Volts DC, Negative Ground
Output Wiring.....Designed for using four speakers only
RCA line out.....low-level outputs - 1000MV
Output Impedance.....Compatible 4 to 8 Ohm Speakers
Fuses.....10 amp
Dimensions.....128mm(W) x 125mm(D) x 100mm (H)
Weight.....2.8 Kg

TFT/SYSTEM

Resolution.....800RGB(H)X480(V)
Brightness/Contrast.....400cd/m²/600
Viewing angle.....70
Response Time.....Tr-2s/Tf-6s
Aspect Ratio.....16:9

FM/TUNER

Tuning Range..... (USA) - 87.5 - 107.9MHz, (Europe) - 87.5 - 108 MHz
FM Sensitivity.....12dBu
Stereo Separation @ 1 Khz.....35dB

AM/TUNER

Tuning Range..... (USA) - 530 - 1710 KHz, (Europe) - 522 - 1620 KHz
AM Sensitivity.....30dBu

BASIC OPERATION



1. Tuning the unit On / Off

Press the Power Button to turn the unit on. The opening screen of the unit will be showing on the TFT monitor. Press and hold the POWER button again to turn the unit off.

2. Turning the TFT On / Off

During any play mode, press the Power Button once to turn the TFT screen off for screen saving and avoid distraction while driving. The sound will continue to play. Press the Power Button again to turn the TFT screen back on.

3 HOME Button

In Radio and Aux modes, press the HOME button to go back to the home screen. You can select different play modes by turning and pressing the volume knob. Also you can enter the setup menu in the home screen.

In USB and SD modes, during music or video playback, press the HOME button once to go back to the directory page, in which you can choose the desired file by pressing and turning the volume knob. Press again the HOME button to go back to the home screen.

4. Wall Paper Selection

Tap the Wall button on the right bottom corner of the OSD. You will enter the wall paper selection screen. Select the image by tapping on the image name then tap OK. The selected image will become the new wall paper on the OSD. You can put more images (BMP files: 720x480) in the map SD card (path: \data\wallpaper) for more selection.

5. Day Light Saving

Tap the Day button on the OSD to increase brightness. Tap again to reduce brightness during night time. Tap again for black out the screen.



Radio Operation



1. Choose Radio Band

Touch the AM button on screen to choose among the five radio bands - three FM Bands (FM1, FM2, and FM3) and two AM Bands (AM1, and AM2). Each of the five bands can store up to six preset stations, for a total of 30 preset memory stations.

2. Radio Seek Function

In Radio Mode, touch and hold  or  Button to adjust the radio frequency automatically. Press the button once to adjust the radio frequency manually.

3. Save Your Preset Stations

Press the  button and then press the  from P1 to P6 to save a preset station.

4. Automatic Store/Preset Scan

While listening to the FM Radio, touch and hold the AMS Button. The receiver will automatically scan and save stations for all the 3 FM Bands, whichever band (FM1, 2 or 3) you are listening to. Touch the AMS button again to scan and listen to the stations you have saved. Repeat the same steps for AM Bands.

5. Mute

Touch the mute button to mute the unit. Touch again to disable the mute.

Radio Operation (Con'd)



6. Mono/Stereo Reception Control

In FM radio mode, touch the ST button to select stereo or mono reception.



7. Local/Distance Reception Control

In radio mode, touch the LOC button to select local or distance reception.

9. RDS Control (Optional)

AF, TA, PTY are the RDS functions. They are applicable to certain countries only. For countries when RDS is not available. The touch sensitivity of the button will be disabled.

10. Returning to Main User Interface

Touch the  button or  button to return to the main user interface.

Bluetooth Operation

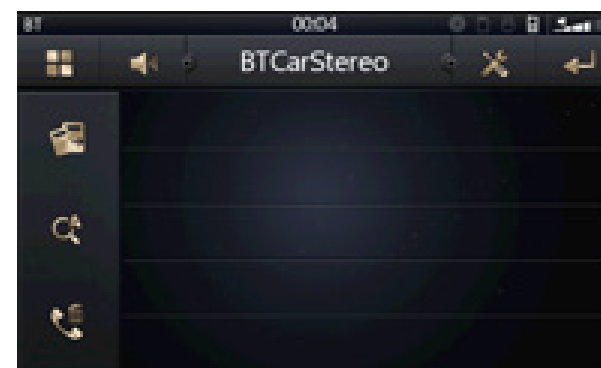
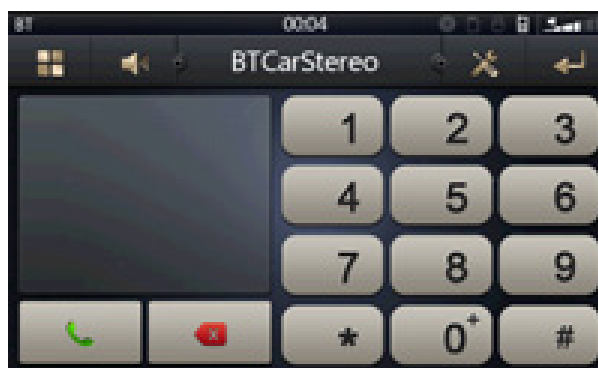
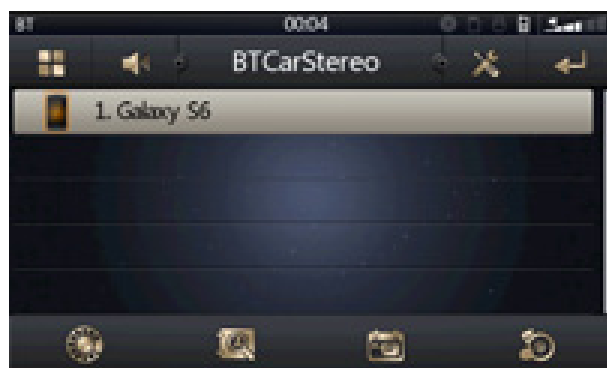



PAIRING

At BT mode, search bluetooth device by the phone and “RMN575BT Caliber” will appear in your phone. Input “0000” as password to establish connection.

DIAL PAD

Touch the dial pad to dial the number you would like to call. Touch the CALL (green) button to send the number.

CONTACT

Press the CONTACT button to enter phone book function. Press the  button to download the phone list. Press the  button to search the contact person. Press the  button to delete the phone list.

CALL RECORD

Press the HISTORY button to enter the phone book page to view received, missed and dialed calls. More details in the next page.

A2DP

Press the MUSIC button to enter the A2DP page to control playing music of your cellphone. More details in the next page.

REJECT CALL

Press the REJECT (red) button to end the call or to reject an incoming call.

RETURN TO USER MANUAL

Touch the  button or  button to return to the main user interface.



Bluetooth Operation (Con'd)



View Received Calls 
Touch the RECEIVED CALLS button, the received calls will be displayed.

View Missed Calls 
Touch the MISSED CALLS button, the missed calls will be displayed.

View Dialed Calls 
Touch the DIALED CALLS button, the dialed calls will be displayed.

Playing Music on your cellphone
After activating music player in the cellphone and it will play automatically, touch  to play or pause the music. Touch  and  to select up or down one song in your song list.

USB Operation

Plug the USB device into the USB port. The unit will play the contents automatically.

1. Advance / Go Back

Advance to the next track or go back to the previous track by pressing the forward or rewind buttons on the front panel or touch screen.

2. Play/Pause

Press the play/pause button to pause the playback or resume.

3. Fast Forward/Fast Rewind

Press and drag the proceeding bar during media playback. The unit will fast forward/rewind the song/video until you release.

4. Directory page

Press the  button during playback in order to see the full list of files along with file types. All the file names are displayed for your easy reference. Select the desired file types and file names by tapping on the screen.

5. Aspect Ratio

During video playback, tap the screen in order to switch the aspect ratio of the video. On the menu you can select full screen, 16:9, and 4:3 accordingly. The viewing effect will depend on the video file so it may vary.

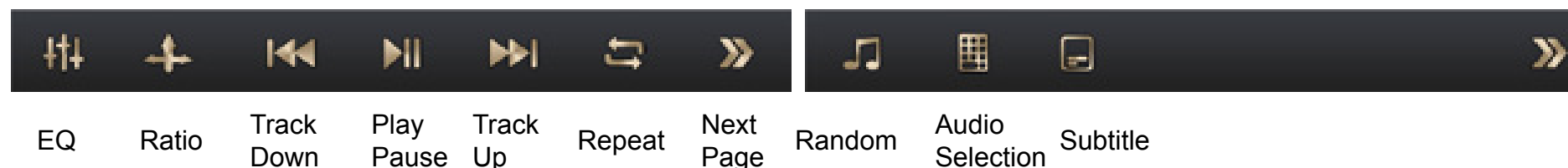

6. Track Search

Press the GOTO button to search the desired track to play the Vedio. Press the ENTER button to confirm your selection.

USB Operation

7. Repeat Function

Press the Repeat button to toggle between repeat chapter, repeat single, repeat all and repeat off.



8. Subtitle Selection

Press the Sub-T button to choose the sub-title you want. The sub-title languages available differ from Disc to Disc. You can also use the setup menu to confirm. Refer to the packing of the Disc for details.

9. Electronic Skip Protection

This unit is programmed with Electronic Shock Protection (ESP) so that the video will be protected against rough roads for 5 seconds.

10. Returning to Main User Interface

Press the  button or  button to return to the main user interface.

Settings



General Setting

The general setting menu includes any key power, video warning, GPS monitor, BT phone book auto deleted, strong sort, brightness, Screen reguate, factory set, calibration, serial and version, GPS monitoring, language setting, reset factory.

Settings



Time Setting

You can select Date, Time, Time mode and Time zone by tapping directly on the options .

Tap  after the setting to take effect.

EQ Setting

You may set EQ, touch sound, back car vol, user def vol, GPS mix, report point remove mute, BT default vol button, BT call vol, def vol under this setting.

Settings

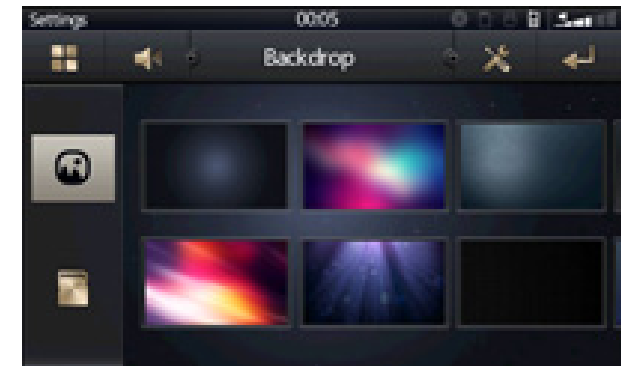

GPS Setting

Enter the GPS setting to define the link of the execution file of your GPS program. Consult the installer if you are not familiar with the setting. Tap OK after the full path is inserted. Now you can enter the Navigation mode in the OSD. Make sure you have inserted the GPS map card properly (the lower micro SD card slot of the front panel) before the settings.



Wall Paper Selection

Tap the Wall button on the right bottom corner of the OSD. You will enter the wall paper selection screen. Select the image by tapping on the image . The selected image will become the new wall paper on the OSD. You can put more images (BMP files: 720x480) in the map SD card (path: \ data\wallpaper) for more selection.

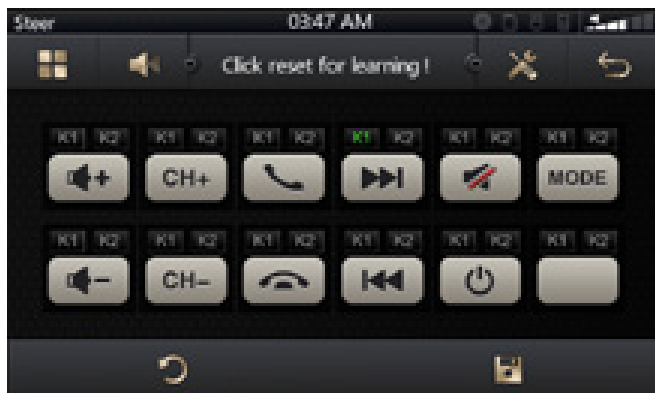
Steering Wheel Control (Optional)



Refer to the wiring diagram for connection. The brown wire (SWC 1) must be connected, then the white or grey (SWC 2A and 2B) will be connected depending on the total number of the wire from the steering wheel remote control of your vehicle.

TAB STEERING WHEEL LOGO in the OSD. Press  before the set up. Select from the 10 functions according to the number of available keys on the steering wheel of your vehicle. Press any key on your steering wheel, then tab the function key you would like to assign. The frequency of the function will be shown on the display. Repeat the step for other keys on the steering wheel. Tab  after your set up is complete and then you can operate the unit by your steering wheel.

Other Operations

1. GPS Navigation If GPS navigation is available with the system, Tap the GPS logo on the OSD to enter GPS navigation. Follow the on screen instruction to input destination and start navigation. The operation varies from software to software.

2. AV Input

The AV Input Jack is a set of composite input on the rear of the unit. Press the Mode button to choose AUX. Connect any portable audio/video device such as a DVD player. Use the volume control to adjust volume.

3. Backup Camera Input

The backup camera input is on the back of the unit. (refer to wiring diagram). This input (in yellow) is for connecting backup camera for parking. You must connect the VCC wire (in pink color) to the reverse gear switch in order to activate this video input mode when you switch the reverse gear of your car. Please refer to the wiring diagram for more details.

4. Video Output

The Video Output Jack is on the back of the unit. (Refer to Wiring Diagram) This output (in yellow) is for connecting monitor(s). You must connect a monitor for car in order to play this unit in another monitor. Consult your dealer for any kinds of monitors that are suitable to use in car. Press the "BND/SYS" button to choose between PAL and NTSC mode.

5. RCA Outputs

The RCA Output Jack is on the back of the unit. (Refer to Wiring Diagram) This output is for connecting amplifier, equalizer, or other audio component that requires a pre-amp out connection. (Red=Right, White=Left) Follow the manufactures instructions for the audio component that you are connecting.

6. Subwoofer Output

The Subwoofer Output Jack is on the output wire harness. (Refer to Wiring Diagram) This output is for connecting up to 2 subwoofer amplifier to the Subwoofer Output Jack to drive a subwoofer. Follow the amplifier's installation instructions. Press and hold the BND/NP/SUB button to activate or deactivate this function.

INFRA RED REMOTE CONTROL

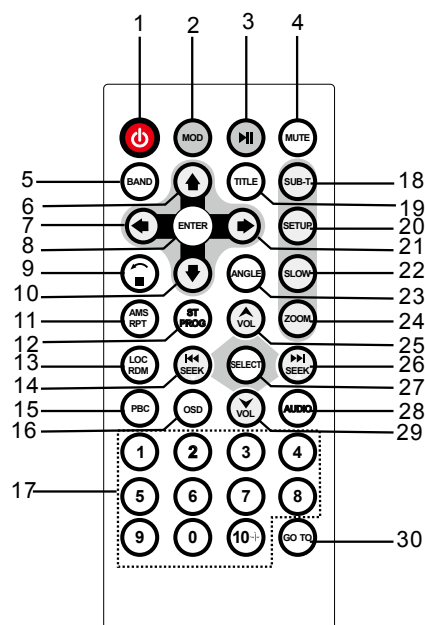

1. Power on/off
2. Mode Select Key
3. Play / Pause Function
4. Mute Sound Function
5. Band Select
- 6/7/10/21. Cursor Button in Menu Mode
8. Confirm The Track/Chapter Selected or Select Item In SETUP Menu
9. Stop Playback
11. Repeat Play Function
12. Program The Tracks To Be Played/Stereo Selection
13. Random Play Function
- 14/26. Track Up / Down or Fast Forward / Backward
15. PBC Play Mode
16. Statistical Disc Information Display Button
17. Number Select Key
18. Subtitle Language Switching Key
19. Show All Track's Title (for DVD units only)
20. Display SETUP Menu
22. Play DVD in Slow Advance
23. Watch The DVD Content From Different Angle
24. Zoom In and Zoom Out Function
- 25/29. Adjust Volume Level
27. Sound Select Button
28. Change The Audio Output Method
30. Track Time Search

SIMPLE TROUBLESHOOTING GUIDE

PROBLEM	CAUSE / SOLUTION
No Power	Check whether the fuse is blown, replace with fuse of proper value if necessary.
Unit stops responding or shows error in display	Press the RESET button.
Unable to receive radio stations	Check whether the antenna is inserted or the antenna is properly connected; if not, insert the antenna or connect it properly.
Poor effect on receiving a station	<ul style="list-style-type: none">-Antenna may not be of the proper length. Make sure the antenna is fully extended. If broken, replace the antenna with a new one.-The broadcasting signal is weak.-The antenna is poorly grounded; check and make sure the antenna is properly grounded at its mounting location.
Discs cannot be loaded	Disc already loaded in the mechanism.
No pictures	<ul style="list-style-type: none">-The video line from main unit to monitor is not connected properly. (for external monitor)-The purple brake wire is not grounded or connected to brake properly.
The picture appears grainy	<ul style="list-style-type: none">-Check the color system. (PAL or NTSC)-The disc is dirty or damaged.

WWW.CALIBER.NL

CALIBER HEAD OFFICE • The Netherlands • Fax: +31 (0)416 69 90 01 • E-mail: info@caliber.nl