

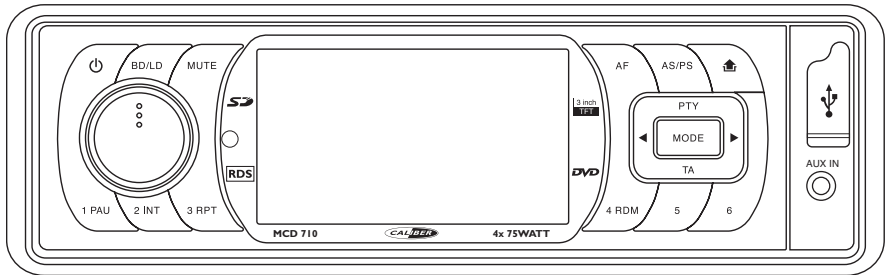

MCD 710

INSTRUCTION MANUAL



Car Stereo
DVD/MPEG4/SVCD/VCD/CD/MP3/WMA Player
with PLL FM Stereo Radio
Radio Data System
3 Inch TFT-LCD Display
USB / SD/MMC Card Input
Front AUX IN
Flip Down/Detachable Front Panel

BEFORE YOU BEGIN

PRECAUTIONS:

CAUTION:

USE OF CONTROLS OR ADJUSTMENT OR PERFORMANCE OF PROCEDURES OTHER THAN THOSE SPECIFIED HEREIN MAY RESULT IN HAZARDOUS RADIATION EXPOSURE.

THE USE OF OPTICAL INSTRUMENTS WITH THIS PRODUCT WILL INCREASE EYE HAZARD.

- Keep this manual handy as a reference for operating procedures and precautions.
- Always keep the volume low enough so you can hear sounds outside of the car.
- Protect this product from moisture.
- If the battery is disconnected or discharged, the preset memory will be erased and must be reprogrammed.

FEATURES:

DVD video playback

It is possible to play back DVD video, DVD+-R, DVD+-RW and DVD+-DL.

Video CDs featuring PBC compatibility

It is possible to play back Video CDs featuring PBC (playback control).

CD playback

Music CD/CD-R/CD-RW playback is possible.

MP3 file playback

It is possible to play back MP3/WMA files recorded on CD-ROM/CD-R/CD-RW.

MP4 file playback

It is possible to play back MP4 files.

PAL/NTSC compatibility

This unit is PAL/NTSC system compatible. When connecting other components to this unit, be sure components are compatible with the same video system or else images will not be correctly reproduced.

Multi-audio

You can switch between multiple audio systems recorded on a DVD as desired.

Multi-subtitle

You can switch between multiple subtitle languages recorded on a DVD as desired.

Multi-angle

You can switch between multiple viewing angles of a scene recorded on a DVD as desired.

When an operation is prohibited

When you are watching a DVD and attempt to perform an operation, it may not be performed by the programming on the disc. When this happens, this unit indicates on the screen.

INSTALLATION

PRECAUTIONS

- Choose the mounting location carefully so that the unit will not interfere with the normal driving functions of the driver.
- Avoid installing the unit where it would be subject to high temperatures, such as from direct sunlight or hot air from the heater, or where it would be subject to dust, dirt or excessive vibration.
- Use only the supplied mounting hardware for a safe and secure installation.
- Be sure to remove the front panel before installing the unit.

NOTE : Inclination angle for car radio installation must not exceed 30° otherwise the front panel will not open.

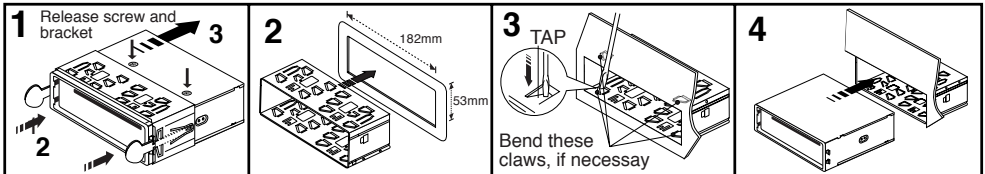

NOTE: Keep the release key in the safe place as you may need it in future to remove the unit from the car.

Detaching and attaching the front panel

The front panel of this unit can be detached in order to prevent the unit from being stolen.

FOLDING DOWN AND DETACHING/ATTACHING THE FRONT PANEL

Before detaching the front panel, be sure to press the button (1) OFF first.

Then press the button, let the Front Panel arrive in horizontal position and detach the panel by pulling it towards you as illustrated.

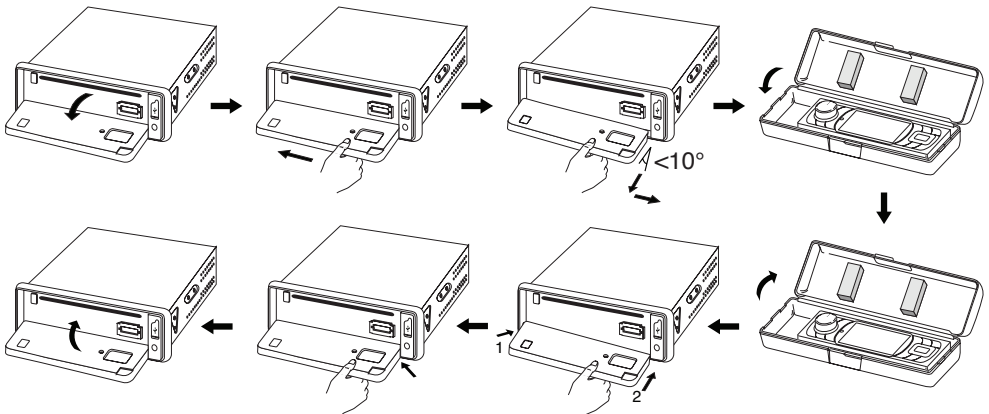

Notes:

- Do not press the front panel hard against the unit when attaching it. It can be easily attached by pressing it lightly against the unit.
- When you carry the front panel with you, put it in the supplied front panel case.
- Do not press hard or give excessive pressure to the display window of the front panel when attaching it to the unit.

CLEANING THE CONNECTOR

The unit may not function properly if the connectors between the unit and the front panel are contaminated with dirt. In order to prevent this from happening, detach the front panel by pressing the button and clean the connector from time to time.

Clean the connector with a cotton swab together with contact cleaner as illustrated. Be sure to clean them carefully pin by pin and make sure not to damage the connecting points.

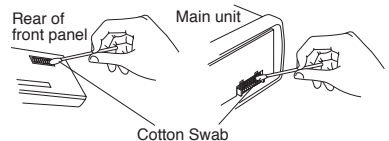

TO SUPPORT THE UNIT

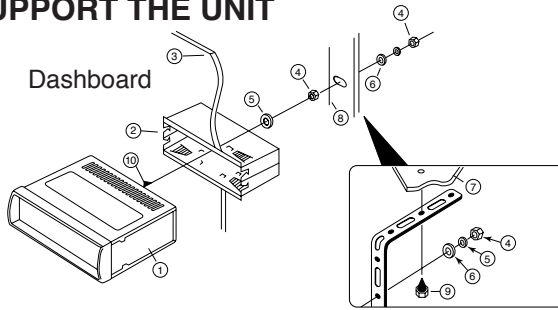

1. UNIT
2. RELEASE CASE
3. DASH BOARD
4. HEX NUT
5. LOCK WASHER
6. PLAIN WASHER
7. CAR BODY
8. REAR SUPPORT STRAP
9. TAPPING SCREW
10. M5 X 15 HEX BOLT

WIRE CONNECTION

IN / OUT CONNECTOR

Audio Out: White (L) Red (R)

Connect this wire to rear seat A/V monitor system to enjoy DVD movie

Audio Out (Front): White (L) Red (R)

Audio Out (Rear): White (L) Red (R)

2 Video Outputs: Yellow

Connect to external A/V system to display

Video In: Yellow

Connect to external Video equipment

Rear camera In: Blue

Connect to rear camera output

CONTROL WIRE

Parking (Gray) : Connect this wire to car hand brake system

Tel mute (Black) : Connect to mobile phone unit

When receiving calls, audio sound will be muted.

Rear camera (Red) : Connect to back rear camera

During back gear condition, this wire should be connected to high voltage.

DRIVING WITHOUT VIDEO DISPLAY

Follow the installation below so when the car is in motion, no video will come out from the LCD screen. Only sound can be heard from speaker.

Note:

- Only sound can be heard when car is in motion.
- Refer and follow your country's law regarding driving with video.

Caution:

- Do not attempt to install it by yourself if the instruction is not clear to you. Consult you dealer concerning the installation procedures.

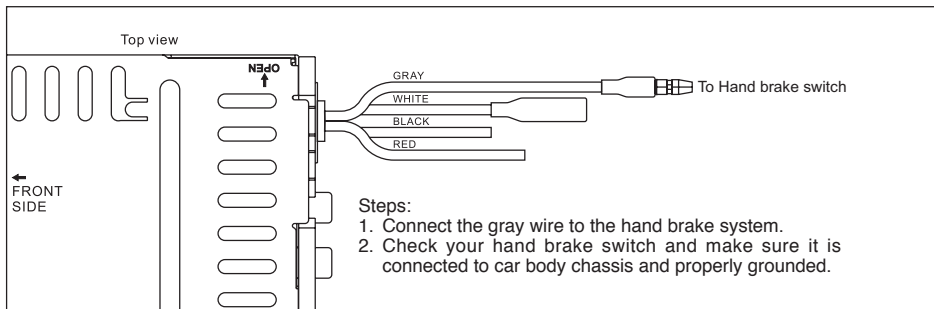

DRIVING WITH VIDEO DISPLAY

By following the installation below, video will always be shown on LCD screen no matter the car is in motion or not.

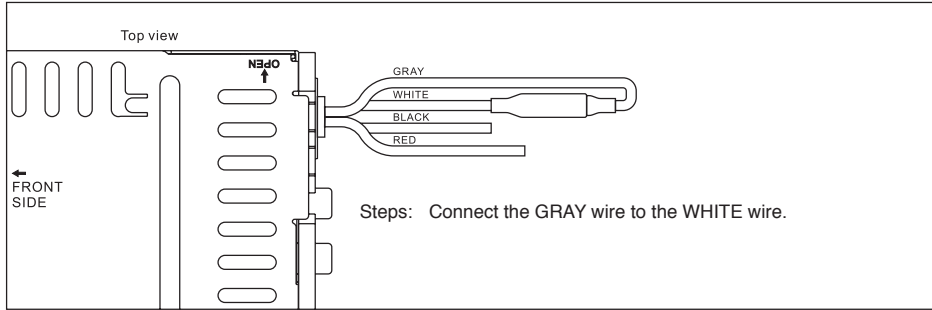

INSTALLING REAR CAMERA FOR PARKING/REVERSE MOTION

You can install an separate camera at the car rear end so when doing parking or reverse motion, the unit will automatically switch the video to the rear camera to guide the driver.

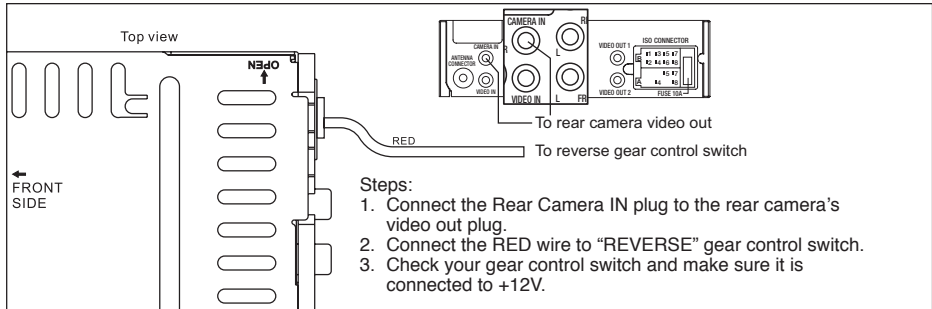

CONNECTOR A

4. MEMORY +12V
5. AUTO ANTENNA OUTPUT
7. +12V (TO IGNITION KEY)
8. GROUND

NOTE: (connector A no. 7) must be connected by car ignition key in order to avoid that car battery becomes weak when the car will be not used for long period.

CONNECTOR B

1. REAR RIGHT SPEAKER (+)
2. REAR RIGHT SPEAKER (-)
3. FRONT RIGHT SPEAKER (+)
4. FRONT RIGHT SPEAKER (-)
5. FRONT LEFT SPEAKER (+)
6. FRONT LEFT SPEAKER (-)
7. REAR LEFT SPEAKER (+)
8. REAR LEFT SPEAKER (-)

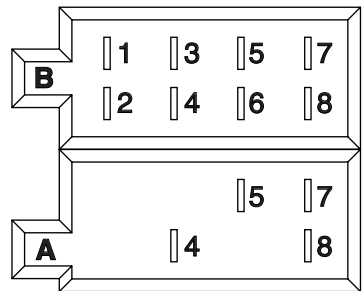

Maintenance

FUSE REPLACEMENT

If the fuse blows, check the power connection and replace the fuse. If the fuse blows again after the replacement, there may be an internal malfunction. In this case, consult your nearest repairing center.

Warning

Use the specified amperage fuse for each lead. Use of a higher amperage fuse may cause serious damage.

LOCATIONS OF PARTS (MAIN UNIT)

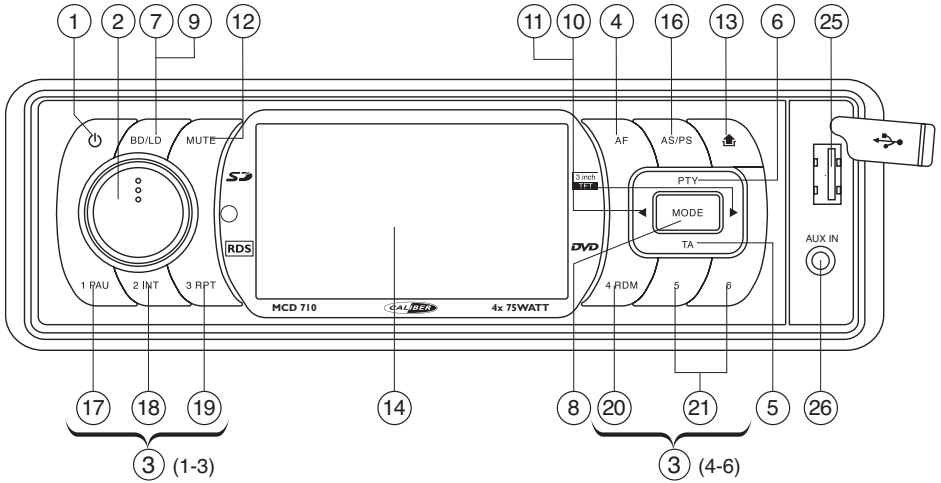

1. POWER ON/OFF (⏻)
2. SELECT FUNCTION BUTTON
3. PRESET STATIONS (1,2,3,4,5,6)
4. 'AF' FUNCTION BUTTON (ALTERNATIVE FREQUENCIES)
5. 'TA' FUNCTION BUTTON (TRAFFIC ANNOUNCEMENT)
6. 'PTY' FUNCTION (PROGRAM TYPE)
7. LOUDNESS BUTTON (LD)
8. MODE BUTTON (MODE)
9. BAND BUTTON (BD)
10. CD TRACK / SEARCH BUTTON
11. AUTO SEEK TUNING
12. MUTE BUTTON (MUTE)
13. PANEL RELEASE BUTTON (🔒)
14. TFT-LCD DISPLAY
15. CD EJECT BUTTON (⏏)
16. AUTO SEEK SEARCH TUNING (AS/PS)
17. PLAY/PAUSE BUTTON
18. INTRO BUTTON
19. REPEAT BUTTON
20. RANDOM BUTTON
21. 10 TRACK SEARCH DOWN/UP
22. RESET BUTTON
23. CD SLOT
24. SD/MMC CARD SLOT
25. USB PORT
26. FRONT AUX IN

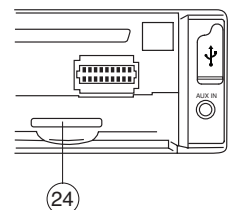
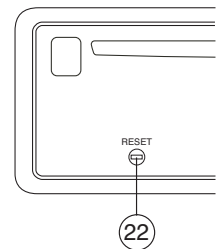
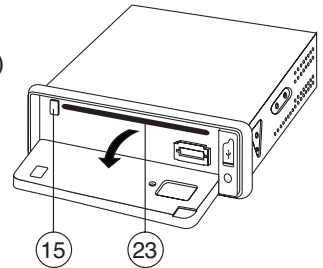

LOCATIONS OF PARTS (REMOTE CONTROL)

1. POWER ON/OFF
2. MODE
3. PLAY/PAUSE
4. TITLE / PLAYBACK CONTROL
5. SELECT
6. SEEK+/SEEK- / CD TRACK/SEARCH
7. VOL +/-
8. GOTO
9. AUDIO
10. ENTER
11. NAVIGATION
12. AUTO SEEK / PRESET SCAN / REPEAT
13. RANDOM / BAND / LOUDNESS
14. DUAL
15. INTRO
16. SUBTITLE
17. SETUP
18. EQUALIZER / ANGLE
19. SLOW MOTION
20. ZOOM / A-B REPEAT
21. STOP
22. CLOCK / ON SCREEN DISPLAY
23. MUTE
24. MAIN MENU
25. STEP (FRAME BY FRAME PLAYBACK)
26. PAL / NTSC SYSTEM
27. PROGRAM TYPE
28. ALTERNATIVE FREQUENCIES
29. TRAFFIC ANNOUNCEMENT
30. 10 TRACK SEARCH DOWN/UP
31. TWO DIGIT TRACKS SEARCHS
32. KEYPAD

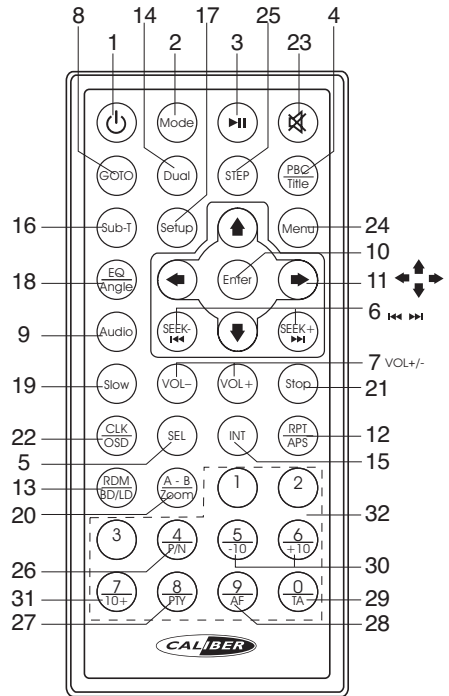

Use and care of the remote control

Installing the battery

Slide the tray out on the back of the remote control and insert the battery with the (+) and minus (-) poles pointing in the proper direction.

- When use for the first time, pull out the film protruding the tray.

CAUTIONS

- Remove the battery if the remote control is not used for a month or longer.
- Do not recharge, disassemble, heat or dispose the battery on fire.
- Do not store the battery with metallic materials.
- In the event of battery leakage, wipe the remote control completely clean and install a new battery
- When disposing of used batteries, please comply with government regulations or environmental public institution's rule that apply in your country/area.
- Always check carefully that you are loading the battery with plus (+) and minus (-) poles facing the proper directions.

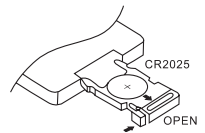

Using the remote control

Point the remote control in the direction of the front panel to operate.

IMPORTANT

- Do not store the remote control in high temperatures or direct sunlight.
- Do not let the remote control fall onto the floor, where it may become jammed under the brake or accelerator pedal.

GENERAL OPERATIONS

Turning the unit ON/OFF (⏻)

Press "⏻" button to turn on unit. To turn off, press and hold the button again.

Selecting a source (MODE)

Press **MODE** repeatedly to switch between TUNER, CD/DVD, AUX IN, USB or SD/MMC mode.

Loading a Disc

1. Press  **REL** to open the front panel
2. Insert a disc into the disc loading slot

Ejecting a Disc

Press  button to eject disc

Adjusting Volume

- Head Unit: Rotate **VOL** knob right or left to increase or decrease volume.
- Remote Control: Press **VOL+** or **VOL-** to increase or decrease volume.

Mute Button

- Head Unit: Press **MUTE** button to mute the sound at once. Press again to return to previous volume level.
- Remote Control: Press  button.

Loud Button (LD)

Press and hold **LD** button to turn on/off LOUD feature.

Equalizer (EQ)

Remote: Press **EQ** button. Under *Dsp-preset*, select the desired EQ by pressing (◀ / ▶).

CLOCK

To show clock, switch to **RADIO** mode and press **CLK** on remote control.

How to Set Clock

1. Press and hold **MENU** on remote control.
2. Using navigation key on remote, select **UTIL** function.
3. Press and hold **CLK** button. Hour start flashing.
4. Press (▲ / ▼) on remote to set the hour. When done, press **CLK** button again to set minutes.
5. Press (▲ / ▼) to set the minutes.
6. Press **X** to save and exit.

DUAL SETTINGS

DUAL is a feature that lets user listen to radio while the passenger at the back can watch video. This unit supports connection of external AV device such as portable TV through the AUDIO OUT and VIDEO OUT port.

1. Connect the AUDIO OUT and VIDEO OUT port at the back of head unit to the LINE IN of external AV device.
2. Press and hold **MODE**. Select memory card or USB source.
3. Press **DUAL** key on remote control to select which mode you want to control.
T = TUNER, C = CARD, U = USB

Note: You will need to connect an external portable TV or monitor when using this feature.

RESET

Reset button is placed on the housing. To reset, use a sharp point object and press and hold the **RESET** button for 2 seconds.

The reset button is to be activated for the following reason:

- Initial installation of the unit when all wiring is completed.
- All the function buttons does not operate.
- Error symbol on the display.

LISTENING TO RADIO

Band (BD)

Pressing this key repeatedly will toggle cyclically between each band. FM1---FM2---FM3-.

Automatic or Manual tuning (SEEK + / SEEK -)

When pressed short, these keys are operated as **MANUAL** tuning mode.

When pressed longer than 1 sec., they are operated as **AUTOMATIC** tuning mode.

Auto Seek/Preset scan (AS/PS)

Preset Scan (PS) - By pressing shortly, the radio plays each preset station for 5 seconds.

Auto Seek (AS) - By pressing longer than 1 sec, auto seek is activated. The 6 strongest stations are preset and stored in the corresponding preset number. When Auto Seek operation is finished, the radio executes the preset scan.

Storing and Recalling Frequencies

If you press any of the NUMBER (1-6) you can easily store up to six broadcast frequencies for later recall with the touch of a button.

1. Choose a desired BAND.
2. When you find a frequency that you want to store in memory, press a NUMBER(1-6) and hold until the preset number shows and lit in the display.
3. The selected radio station frequency has been stored in memory. The next time you press the same NUMBER (1-6) the radio station frequency is recalled from memory.

Note: Up to 6 stations can be stored in each band.

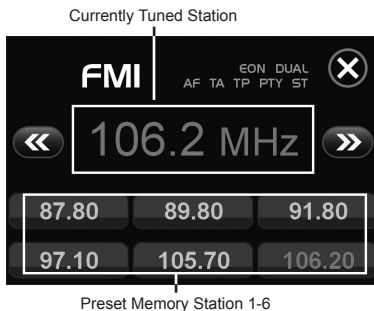

USING THE RDS FUNCTION

What is RDS?

The RDS (Radio Data System) is a digital information system developed by the EBU (European Broadcast Union). Piggy-backed on normal FM broadcasts, RDS offers a variety of information services and automatic retuning functions for RDS-compatible car stereos. In 1988, RDS became available in the United Kingdom, France, West Germany, Ireland and Sweden.

'AF' Function (Alternative Frequencies)

- When pressed short, AF switching mode is selected.
- The radio checks the signal strength of the AF all the time, when it becomes too weak, the unit detects f from the AF signal on which frequencies it must search for a better transmitter.

'TA' Function (Traffic Announcement)

When pressed short, it is activated as TA mode on or off. When TA mode is on and traffic announcement is transmitted.

- When the unit is in CD/MP3 mode, it will switch to radio mode temporarily.
- If the volume level was under the threshold point, it will be raised to the threshold point.

'PTY' Function (Program Type)

1. Press and hold **PTY** button to turn ON Program type.
2. Rotate **VOL** knob to select program type.
3. Once desired program shows, simply press **PTY** button once more and unit start searching for available stations.

Note: Program type will flash when searching for stations.

OPERATIONS COMMON FOR CD/MP3/VCD/DVD/MP4

-10 Tracks Down / +10 tracks Up

1. Press **-10** button to jump 10 tracks backward starting from currently played track.
2. Press **+10** button to jump 10 tracks forward starting from currently played track.

Specifying particular track

During playback, all track file names under a folder will be displayed on the screen with their corresponding track number. You can use the navigation keypad on the remote control to access the file.

Tips:

To select track 3, press 3.

To select 13, press and hold 10+ follow by 3.

To select 23, press and hold 10+ (2 times) follow by 3.

Random Playback

Press **RDM** during playback to play the tracks in random/shuffle order. Press it again to cancel.

Stopping Playback

1. Press **Stop** on remote control during playback to stop playback. That position is stored in memory.
2. Press **▶||** to continue. Playback starts from the position at which it was stopped.

*Note: There is no **STOP** function in audio playback. Audio playback uses **▶||** function.*

Fast Forward / Fast Reverse

Note: ◀◀ or ▶▶ on remote control is the same function as ◀ or ▶ on head unit.

1. During playback, press and hold ◀ or ▶ unit scans at the speed of x2 - x4 - x8 - x16 - x20
2. To resume normal playback at a desired point, press ▶▶ .

Note: No sound is played during fast forward / fast reverse.

Finding the Beginning of Tracks

During playback, press ◀ or ▶ .

- ◀ : Press to start playback from the beginning of the previous chapter or track.
- ▶ : Press to start playback from the beginning of the following chapter or track.

Pause Playback

During playback, press ▶▶ . Press again to resume playback.

A-B Repeat Playback

This feature allows you to loop playback a section of the movie starting from Point A to B.

1. Press the ▶▶ button to play the movie.
2. Once you have located the section you wish to playback on loop repeat, press and hold **A-B** button. You will see "Rep-A" on the screen.
3. Let the movie play on until you have reached the end of the section you wish to watch on continuous loop. Once you have reached this point, press and hold **A-B** button again. "Rep-A-B" will appear on your screen. Playback will now start from Point A-B.
4. To stop A-B repeat playback, press and hold **A-B** button once more until "A-B CANCEL" disappears and normal playback resumes.

Displaying information (OSD)

During playback, you can see all DVD disc information and current play settings. Display will show related playback time, elapse time, title number, chapter number and other information.

1. Press **OSD** on the remote control once. Unit will display the play time and the disc elapse time.
2. Press it once more and all other settings information will be displayed.

LISTENING TO CD/MP3/WMA

Searching for particular track using GOTO

You can use the GOTO function to search for a desired track number or particular point of a track to play.

1. Press **GOTO** on the remote control during playback. Time and track number search appears.
2. Enter the minutes and seconds for the currently played track if you want to search by time. Press **Enter**.
3. Enter track number if you want to search by tracks. Press **Enter**.

Intro Playback (Audio CD only)

Press **INT** during playback to play the first 10 seconds of each track.

Repeat tracks

You can choose between repeat playback of a single track or all tracks.

1. Press **RPT** on the remote control during playback.
2. Every time you press this button, the unit switches to the following settings:

Repeat 1 ◀1 – Repeat the current playback track.

Repeat All ◀ALL – Repeat all folders and tracks.

SD/MMC Card Input

Support MP3/WMA ID3 format music only.

1. Press **REL** button and the the front panel will open.
2. Detach the panel by pulling it towards you.
3. Carefully insert the SD/MMC card into the disc slot, attach back the panel. Unit starts playback automatically.

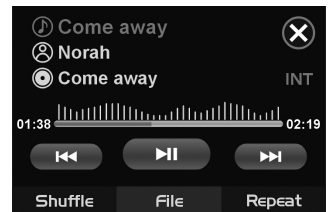

Player File Info

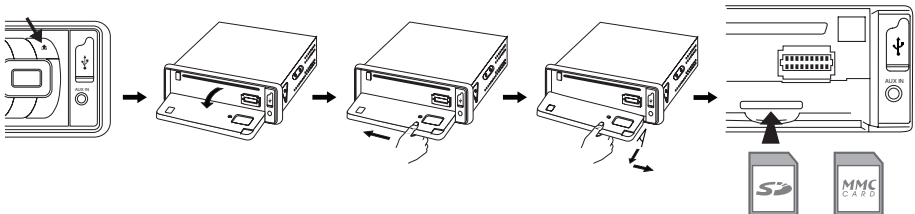

Front USB Port

Using USB cable to connect Your Portable MP3 Player.

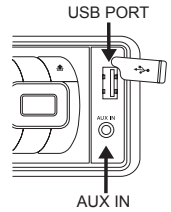

*** IMPORTANT INFORMATION:**

BECAUSE OF THE GREAT VARIETY OF PRODUCTS WITH USB, SD AND MMC CARD PORTS AND THEIR SOMETIMES QUITE MANUFACTURER-SPECIFIC FUNCTIONS WE CAN NEITHER GUARANTEE THAT ALL DEVICES WILL BE RECOGNIZED NOR THAT ALL OPERATING OPTIONS THAT ARE POSSIBLE IN THEORY WILL ACTUALLY WORK

Front Aux In

Convenient easy to use front "AUX IN" input jack, allows easy connection of Portable Media and other digital MP3 Players.

PLAYING DVD/VIDEO CD/MP4

Playback

1. Insert a disc. When the disc offers a menu, the menu is displayed. When a disc already inserted, press **MODE** to switch to disc mode.
2. On DVDs and video CDs with playback control (PBC), menu screens may appear automatically. If this happens, perform the operation described below to start playback.

CAUTION: Make sure that the Video TV system settings is set correctly according to your disc your playing. If you are not sure, leave it set to "**Auto**". Improper setup of TV system might cause the video to stop/skip/pause playing although audio might continue to play. You can setup video TV settings using the **SETUP** feature of the remote control. Refer to "**SETTING UP THE DVD PLAYER**" section.

DVD menu

Press **▲**, **▼**, **◀**, **▶** to select the desired item, then press **Enter**.

Video CD menu

Use the number keys ("0" to "9") to select the desired number, then press **Enter**. The menu screen does not appear when the PBC function is turned off. In this case, press and hold button to turn on PBC feature.

Turning PBC ON/OFF (VCD only)

PBC (Playback Control) is a feature found on VCD 2.0 and SVCD 1.0. PBC allows control of the playback of play items and the possibility of interaction with the user through the remote control or some other input device available. If it's on, the player won't auto start after inserting the disc because it will take time to select program on disc; if it's off, the player will auto playback the program on disc one by one.

1. To turn ON PBC function, press **PBC** on the remote control. To turn OFF, press the button again.

Note: Not all VCD/SVCD disc have PBC functions.

Repeat Playback

FOR VCD

1. Press **RPT** on the remote control during playback.
2. Every time you press this button, the unit switches to the following settings:

Repeat 1 – Repeat the current playback track.

Repeat All – Repeat all folders and tracks.

Off – Turn repeat function OFF.

Note: PBC feature in VCD disc needs to be STOP in order to use Repeat playback.

FOR DVD

You can choose between repeat playback of a title or chapter.

1. Press **RPT** on the remote control during playback.
2. Every time you press this button, the unit switches to the following settings:

Repeat Title – Repeat the current playback title. (Press and hold **RPT** button)

Repeat Chapter – Repeat the current playback chapter.

Repeat All – Repeat all folders and tracks.

Repeat Off – Turn repeat off.

Searching for particular track using GOTO

You can use the GOTO function to search for a desired track number or particular point of a track to play.

1. Press **GOTO** on the remote control during playback. Time and track number search appears.
2. Enter the minutes and seconds for the currently played track if you want to search by time. Press **Enter**.
3. Enter track number if you want to search by tracks. Press **Enter**.

Changing audio language during playback (Multi-audio)

DVDs can provide audio playback with different languages and different systems (Dolby Digital, DTS etc.). With DVDs featuring multi-audio recordings, you can switch between languages/audio systems during playback. VCD can provide different audio languages usually divided into left and right channels.

1. To choose different audio, simply press **Audio** on the remote control repeatedly during playback.

Note:

- With some DVDs, switching between languages/audio systems may only be possible using a menu display.
- You can also switch between languages/audio systems using **SET-UP MENU**.

Changing the subtitle language during playback

(Multi-subtitle) – (DVD only)

With DVDs featuring multi-subtitle recordings, you can switch between subtitle languages during playback.

1. Press **Sub-T** on the remote control during playback. Press repeatedly until the supported desired subtitle appears.

Note:

- With some DVDs, switching between subtitles may only be possible using a menu display.
- You can also switch between subtitles using **SET-UP MENU**.

Changing the viewing angle during playback (Multi-angle) – (DVD only)

With DVDs featuring multi-angle (scenes shot from multiple angles) recordings, you can switch among viewing angles during playback.

1. Press and hold **Angle** on the remote control during playback of a scene.

Title (DVD only)

During DVD playback, press **Title** on remote control to return to FIRST title.

Return to Root Menu (DVD only)

During DVD playback, press and hold **MENU** on head unit or remote control to return to root menu.

Note: Some DVD may not contain root menu.

Slow motion playback

This feature lets you slow down playback.

1. Press **Slow** on the remote control during playback.
2. Pressing it repeatedly will switch you to the following steps: 1/2 - 1/3 - 1/4 - 1/5 - 1/6 - 1/7.

Note:

- To resume normal playback, press **PLAY/PAUSE (▶||)**.
- There is no sound during slow motion playback.
- With some disc, slow motion may be unclear during slow motion playback.

Zooming in During Playback

You can zoom in into the picture during playback.

1. Press **ZOOM** on the remote control during playback.
2. Every time you press this button, the unit will zoom 2 - 3 - 4 - 1/2 - 1/3 - 1/4 times and OFF.

Frame-by-frame playback

This lets you move ahead one frame at a time during playback.

1. Each time you press **Step** button on remote control, you move ahead one frame.

To return to normal playback, press **▶||**.

PAL / NTSC (P/N)

Press and hold **P/N** button to switch between PAL, NTSC, AUTO system.

CUSTOMIZING AUDIO / VIDEO SETTINGS

AUDIO SETUP

1. Press **VOL** knob to enter AUDIO setup. Selected item will be highlighted. You can set BASS, TREBLE, BALANCE, FADER, TA VOLUME.
2. Press **◀** or **▶** button to select item. Rotate **VOL** knob to make adjustments.
3. Press **VOL** knob to exit settings.

VIDEO SETUP

1. Press and hold **VOL** knob to enter VIDEO setup. Selected item will be highlighted. You can set BRIGHTNESS, CONTRAST, SATURATION, HUE, SHARPNESS.
2. Press **◀** or **▶** button to select item. Rotate **VOL** knob to make adjustments.
3. Press and hold **VOL** knob to exit settings.

Note: Depending on model's feature, some items may not show on screen.

SETTING UP THE DVD PLAYER

You can flexibly customize the unit to suit your preference. You can set the language and other video and audio settings so when playback starts it will always use your preferred settings.

Important:

1. Load any disc into the unit before you can access the setup.
2. Press **Setup** on the remote control.

Settings	Category	Options
System Setup	TV System	NTSC, PAL, AUTO
	Auto Play	ON, OFF
	TV Type	4:3PS, 4:3LB, 16:9
	Password	Setup password
	Rating	Setup rating level
	Default	Restore to factory settings
Language Setup	OSD Language	Select preferred options appear on screen
	Audio Language	
	Subtitle Language	
	Menu Language	
	MPEG4 Language	
Audio Setup	Audio Out	Analog
	Key	Setup key level

Setting Rating Password

- 1 Press **Setup** on the remote control.
- 2 Using Navigation keys select *System Setup > Password* and press **Enter**.
- 3 Enter the default password '**0000**' and press **ENTER** to unlock first and then enter new 4 digit password and press **ENTER**. The unlock logo will switch to lock indicating password has been set.

Note:

- *The default password is '0000'.*
- *In case you forgot your password, you can use the master password '0000' to unlock and reset the password.*
- *Master password will only work while SETUP button is press during playback.*

TECHNICAL SPECIFICATIONS

CD/MP3/WMA PLAYER SECTION

Signal to Noise Ratio	> 60 dB
Channel Separation	> 50 dB (1kHz)
Frequency Response	20 Hz - 20 kHz

TUNER (FM)

Frequency Range	87.5-108 MHz
Channel Step	50 kHz
Sensitivity	2.8 μ V
Stereo Separation	30 dB
Signal to Noise Ratio	50 dB

LINE-OUT

Output	1300 mV (max.)
Impedance	10k Ohm

GENERAL

Power Supply	12V DC (10.8-15.6V allowable)
Speaker Impedance	4 or 8 Ohm
Output power	75W x 4CH

Note: Specification and the design are subject to possible modification without notice due to improvements.